

GENEBRE
Be water. Be Genebre.

COLECCIÓN | COLLECTION
Grifería | Taps
Cocina y Baño | Kitchen & Bathroom

Архангельск (8182)63-90-72
Астана +7(7172)727-132
Белгород (4722)40-23-64
Брянск (4832)59-03-52
Владивосток (423)249-28-31
Волгоград (844)278-03-48
Вологда (8172)26-41-59
Воронеж (473)204-51-73
Екатеринбург (343)384-55-89
Иваново (4932)77-34-06
Ижевск (3412)26-03-58
Казань (843)206-01-48

Калининград (4012)72-03-81
Калуга (4842)92-23-67
Кемерово (3842)65-04-62
Киров (8332)68-02-04
Краснодар (861)203-40-90
Красноярск (391)204-63-61
Курск (4712)77-13-04
Липецк (4742)52-20-81
Магнитогорск (3519)55-03-13
Москва (495)268-04-70
Мурманск (8152)59-64-93
Набережные Челны (8552)20-53-41

Нижний Новгород (831)429-08-12
Новокузнецк (3843)20-46-81
Новосибирск (383)227-86-73
Орел (4862)44-53-42
Оренбург (3532)37-68-04
Пенза (8412)22-31-16
Пермь (342)205-81-47
Ростов-на-Дону (863)308-18-15
Рязань (4912)46-61-64
Самара (846)206-03-16
Санкт-Петербург (812)309-46-40
Саратов (845)249-38-78

Смоленск (4812)29-41-54
Сочи (862)225-72-31
Ставрополь (8652)20-65-13
Тверь (4822)63-31-35
Томск (3822)98-41-53
Тула (4872)74-02-29
Тюмень (3452)66-21-18
Ульяновск (8422)24-23-59
Уфа (347)229-48-12
Челябинск (351)202-03-61
Череповец (8202)49-02-64
Ярославль (4852)69-52-93

Единый адрес для всех регионов: grb@nt-rt.ru || www.genebre.nt-rt.ru



Índice | *Index*

- 004** Be water, be Genebre
- 004** Calidad | *Quality*
- 005** Medio ambiente | *Environment*

- 006** Kode
- 012** Oslo
- 018** Klip
- 026** Klip 2
- 032** Kelogic
- 038** Tau
- 048** Tau 2
- 054** Kenjo
- 062** Inox
- 066** Ge 2
- 074** Sigma
- 082** New Regent Classic
- 088** New Regent
- 098** Gamma
- 108** Kalo
- 112** Kross
- 116** Ixo
- 120** Style Shower
- 126** Accesorios | *Accessories*
- 144** Recambios | *Spare parts*

- 153** Simbolos | *Symbol*
- 154** Información Técnica | *Technical information*

- 202** Índice por referencia | *Index by reference*



Colección | *Collection*

Tan adaptables como el agua

Tenemos el placer de presentarte nuestra nueva colección de grifería. Una búsqueda de nuevos conceptos y tendencias que fusiona la elegancia, la tecnología y los más altos estándares de calidad. Líneas minimalistas, robustas y de gran belleza que armonizan con la versatilidad y el uso responsable del agua. Infinidad de modelos, acabados y sistemas que, además de crear exquisitos ambientes en baños y cocinas, aumentan el bienestar y ayudan a cuidar el medio ambiente. El resultado: una colección tan adaptable como el agua, en la que cada diseño es especial y único.

As adaptable as water

We are pleased to introduce our new collection of taps to you. A search for new concepts and trends that mix elegance, technology and the highest quality standards. Beautiful, robust, minimalist lines offer versatility combined with the responsible use of water. An infinity of models, finishings and systems which enhance well-being and help to protect the environment, in addition to creating exquisite ambiances in bathrooms and kitchens. The result: a collection as adaptable as water itself, in which each design is special and unique.



Be water | *Be Genebre*

El agua es la esencia de la vida

El agua es un bien fundamental para la vida y el planeta, pero también un recurso escaso y limitado cuyo consumo va en aumento. Estamos acostumbrados a verla correr y, hasta hace poco, se creía inagotable. Sin embargo, hoy sabemos que la mayor parte del agua de la Tierra es salada o se encuentra en forma de casquetes polares o glaciares, y solo una pequeña parte es útil para los procesos vitales del planeta. De modo que para su conservación en el futuro se necesita una actitud responsable diaria y una mayor conciencia ambiental de cada uno de nosotros. Podemos soñar con un futuro más sostenible, pero para que este sueño se haga realidad debemos empezar desde el presente. Desde hoy.

Water is the essence of life

Water is an essential resource for life and for the planet. At the same time, water is also scarce and limited. In our minds, water is always running, and until recently, it was thought to be in endless supply. However, its usage is increasing. Today we know that most of the water on Earth is salt water, or is found in the form of glaciers or ice caps, and only a small part is usable for the planet's vital processes. Therefore, to conserve water for the future, each and every one of us needs to have a responsible attitude towards it, as well as greater environmental awareness. We can dream about a more sustainable future, but in order to make this dream a reality, we have to start now. Starting today.



Calidad | *Quality*

La grifería GENE BRE está diseñada y fabricada según los estándares europeos de calidad, como la UNE-EN 19703 ofreciendo así al cliente la funcionalidad, durabilidad y seguridad esperadas.

El latón empleado en nuestros cuerpos y componentes pertenece a las aleaciones CC754S según norma EN 1982 y CW617N según norma EN 12165. Las superficies cromadas cumplen la norma EN 248, resistencia a la niebla salina 5% (NaCl), Ph 6,5 T 36°C, según ISO 9227. Los atomizadores cuentan con casquillos en latón cromado resistente a la corrosión y cartucho aireador en plástico anti calcáreo, según lo especificado en la norma EN 246. Utilización de cartuchos mezcladores con discos cerámicos de alta calidad fabricados en Al₂O₃ 99%, según normas EN 200 y NF 077 capaces de resistir 200.000 maniobras y ofrecer la suavidad y estanqueidad originales. Los sistemas de giro de los caños han sido fabricados según norma EN 817, siendo capaces de resistir las 80.000 maniobras. Empleamos válvulas anti retorno en mezcladores según norma EN1717 a fin de asegurar la no intercomunicación. Todos los cartuchos termostáticos están dotados de un sistema de seguridad anti escaldamiento según norma EN 1111. Mangos de ducha fabricados según norma EN 1112. Flexos de ducha fabricados según norma EN 1113. La garantía de los productos GENE BRE está mundialmente reconocida. Ofrecemos un servicio de asistencia técnica, así como resolución de incidencias. A fin de asegurar el cumplimiento de estas normas la empresa GENE BRE y sus productos poseen diferentes Homologaciones y Certificaciones: ISO 9001:2008 Sistema de Gestión de la Calidad. ISO 14001:2004 Sistema de Gestión Ambiental.

GENEBRE posee productos homologados por el Ministerio de Industria y Energía de España. Productos con cumplimiento de Norma NSF-61. Homologación AENOR para conexiones flexibles usadas en nuestros productos.

Certificación de mecanismos y componentes en laboratorios certificados por ENAC.

Certificación de productos por "Laboratorios Oliver Rodes", confirmando el cumplimiento de los criterios sanitarios de la calidad del agua para el consumo humano (RD 140/2003 de 07 de febrero (legislación española) y de la directiva europea 98/83/CE del Consejo Europeo de 03 de noviembre del 1998, relativa a la calidad de las aguas destinadas del consumo humano.

The GENE BRE's taps are designed and manufactured in compliance with European standards, such as UNE-EN 19703, to comply with and exceed the European Product Directives, thereby offering customers the desired functionality, durability and safety.

The brass used in our bodies and components comes from alloy CC754S, in compliance with standard EN 1982 and alloy CW617N in compliance with standard EN 12165.

Chromed surfaces in compliance with EN 248, resistant to 5% salt spray (NaCl), PH 6.5 T 36°C, in compliance with standard ISO 9227.

The aerators have chrome-plated brass sockets resistant to corrosion and plastic anti-lime scale aerator cartridges, in compliance with standard EN 246.

Use of mixing cartridges with high-quality ceramic discs manufactured in Al₂O₃ 99%, in compliance with standards EN 200 and NF 077 capable of withstanding 200,000 manoeuvres and offering the original softness and water tightness.

The rotation systems of the water spouts have been manufactured in compliance with standard EN 817 and are capable of withstanding up to 80,000 manoeuvres.



We use anti-backflow valves in mixers in compliance with standard EN1717 to ensure there is no backflow. All thermostatic cartridges are fitted with an anti-scalding security system in compliance with standard EN 1111.

Handshowers are manufactured in compliance with standard EN 1112.

Shower hoses are manufactured in compliance with standard EN 1113.

The guarantee of GENE BRE's products is internationally recognised.

We provide a technical assistance service, as well as an incident resolution service.

By means of ensuring these standards are complied with, the company GENE BRE and its products hold different Approvals and Certifications: ISO 9001:2008 Quality management system ISO 14001:2004 Environmental management system

GENE BRE owns products approved by the Spanish Ministry of Industry and Energy.

Our products comply with standard NSF-61. AENOR approval for the flexible connectors used in our products. Certification of mechanisms and components in ENAC-accredited laboratories.

Certification of products by "Laboratorios Oliver Rodas", confirming compliance with the sanitary criteria for the quality of water for human consumption (RD 140/2003 dated 7 February – Spanish legislation) and European Directive 98/83/EC of the European Council dated 3 November 1998 relating to the quality of water intended for human consumption.



Medio ambiente | *Environment*

Promoviendo la sensibilidad y el respeto por el medioambiente

Genebre es una compañía comprometida con el medioambiente. Su visión de un futuro sostenible y una filosofía enfocada a proteger el agua y los fluidos le permiten mejorar, investigar, desarrollar y crear conceptos innovadores a partir de las tecnologías más punteras. De manera que aplica siempre criterios que transmitan valores ecológicos en todos sus productos y a la vez que satisfagan las necesidades de funcionalidad, confort y diseño de los usuarios.

Actualmente, Genebre está colaborando en el programa de I+D NUESVAL. Un estudio coordinado por el Centro Tecnológico de Manresa cuyo objetivo es desarrollar nuevas aleaciones de latón para válvulas de conducción de fluidos en condiciones ambientales de alta temperatura. Un modelo de proyecto basado en la innovación, en el que Genebre ha depositado su compromiso empresarial, con el fin de desarrollar tipos específicos de válvulas destinadas tanto a instalaciones domésticas como industriales.

Promoting respect for the environment

Genebre is a company committed to the environment. Its vision of a sustainable future and a philosophy focused on protecting water and fluids allow it to improve, research, develop and create innovative concepts using the most advanced technologies. Genebre always applies the same criteria which transmits ecological values in all of its products, and at the same time satisfies the users' needs of functionality, comfort, and design.

Currently, Genebre is collaborating in the NUESVAL R+D program, a study coordinated by the Centro Tecnológico de Manresa, whose objective is to develop new brass and bronze alloy for valves. It is a project model based on innovation, in which Genebre reinforces its commitment to developing specific types of valves for domestic as well as industrial installations.

Kode

Acabado cromado. Cartucho 40 | *Chromed finish. Cartridge 40*

ROBUSTEZ ESTILIZADA

Inspirada en las nuevas tendencias, la nueva serie Kode deja entrever un estilo robusto y dinámico de maneta prominente con formas redondeadas que la matizan. Un magnífico diseño de alta gama creada para los baños de última generación.

STYLIZED ROBUSTNESS

Inspired in new trends, the new Kode series reveals a robust, dynamic style with a prominent handle with round forms that match. A magnificent high-end design created for new generation bathrooms.



Kode Monomando Lavabo | *Single lever wash-basin mixer*



Ref.: 62130 08 45 66
Monomando de lavabo
Single lever wash-basin mixer
Cartucho 2 posiciones | 2-position cartridge



Ref.: 62136 08 45 66
Monomando de lavabo alto
High single lever wash-basin mixer
Cartucho 2 posiciones | 2-position cartridge

Kode Lavabo empotrado | *Built-in single lever wash-basin mixer*



Ref.: 62131 31 45 66
Monomando de lavabo empotrado caño 16 cm.
Built-in wash-basin mixer 16 cm spout



Ref.: 62132 31 45 66
Monomando de lavabo empotrado caño 22 cm.
Built-in wash-basin mixer 22 cm spout

Kode Monomando bidé | *Single lever bidet mixer*



Ref.: 62140 08 45 66
 Monomando de bidé
Single lever bidet mixer
Cartucho 2 posiciones | 2-position cartridge



Ref.: 62142 31 45 66
 Monomando de bidé con transmisión
Single lever bidet mixer with diverter

Kode Baño y Ducha | *Bath & shower*



Ref.: 62100 08 45 67
 Monomando de baño sin kit
Single lever bath mixer without kit
Cartucho 2 posiciones | 2-position cartridge



Ref.: 62110 31 45 67
 Monomando de ducha sin kit
Single lever shower mixer without kit
Cartucho 2 posiciones | 2-position cartridge



Ref.: DX03 45
 Mango de ducha O3 jets (caja)
O3 jets handshower (box)
Ref.: 100137 60 00
 Flexo extensible 1,70-2,25 m inoxidable doble grapaje
Extensible double lock stainless steel flexible hose 1.7-2.25 m
Ref.: 100068 45
 Soporte ducha ovalado
Oval shower holder

Kode Empotrados | *Built-in single lever bath & shower mixers*



Ref.: 62115 31 45 66
Monomando de ducha empotrado
Built-in single lever shower mixer



Ref.: 62117 31 45 66
Monomando empotrado con inversor cerámico 2 vías
Built-in single lever mixer with 2-way ceramic diverter



Ref.: 62118 08 45 66
Monomando empotrado con inversor cerámico 3 vías
Built-in single lever mixer with 3-way ceramic diverter

Kode Inversor | *Diverter*



Ref.: 62114 30 45 66
Inversor cerámico 3 vías empotrado con placa ovalada
Built-in 3-way ceramic diverter with oval plate



Kode Style Shower



Ref.: 62114 30 45 66

Inversor cerámico 3 vías empotrado con placa ovalada

Built-in 3-way ceramic diverter with oval plate

Ref.: 62115 31 45 66

Monomando de ducha empotrado

Built-in single lever shower mixer

Ref.: 1643 45

Rociador doble función cascada-lluvia

Double function shower head, waterfall-rain

Ref.: 1680 04

Toma ducha mural redonda

Round flexible wall connector

Ref.: 1636 45

Barra ducha TAU (caja)

TAU shower bar (box)

Ref.: 100137 60 00

Flexo 1,70 m. - 2,25 m. inoxidable extensible doble grapaje.

Extensible double lock stainless steel flexible hose 1.7-2.25 m

Ref.: DX03 45

Mango de ducha O3 jets (caja)

O3 jets handshower (box)



Ref.: 62118 08 45 66

Monomando empotrado con inversor cerámico 3 vías

Built-in single handle mixer with 3-way ceramic diverter

Ref.: B65113 18

Brazo pared redondo 35 cm.

Round arm 35 cm

Ref.: R63112 08

Rociador ovalado 22 cm

Oval shower head 22 cm

Ref.: 1680 04

Toma ducha mural redonda

Round flexible wall connector

Ref.: 1636 45

Barra ducha TAU (caja)

TAU shower bar (box)

Ref.: 100137 60 00

Flexo 1,70 m. inox extensible doble grapaje hasta 2,25 m.

Extensible double lock stainless steel flexible hose 1.7-2.25 m

Ref.: DX03 45

Mango de ducha O3 jets (caja)

O3 jets handshower (box)

Ref.: 1668 45

Caño mural baño cilíndrico

Round wall bath spout

Oslo

Acabado cromado. Cartucho 35 | *Chromed finish. Cartridge 35*

VANGUARDISMO Y SENCILLEZ

Una línea estilizada de formas depuradas y ángulos rectos es la base de la serie Oslo. Una nueva colección con diferentes alturas de caños, que proyecta elegancia y esbeltez y un avanzado diseño vanguardista donde cada detalle está pensado para embellecer el baño.

VANGUARDISM AND SIMPLICITY

A stylized line of pure forms and right angles is the basis of the Oslo series. A new collection, with different spout heights, which projects elegance and slenderness, and has an advanced vanguardist design where each detail is intended to beautify the bathroom.



Oslo Monomando Lavabo | *Single lever wash-basin mixers*

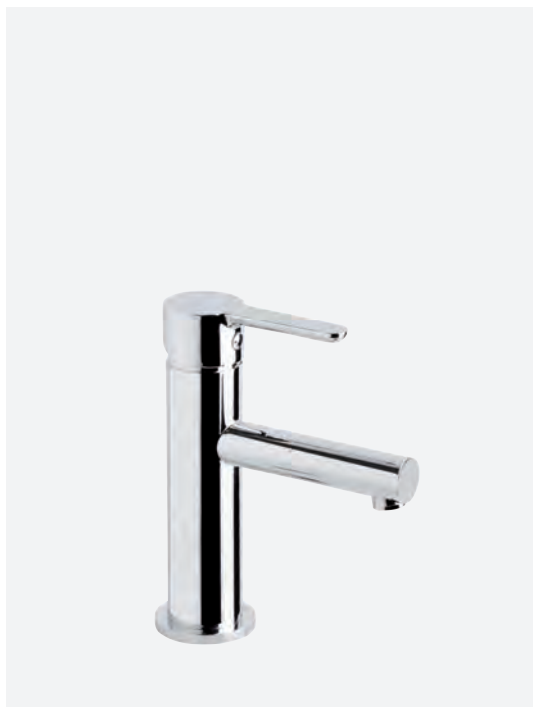

Ref.: 65130 19 45 66
Monomando de lavabo
Single lever wash-basin tap
Cartucho 2 posiciones | 2-position cartridge

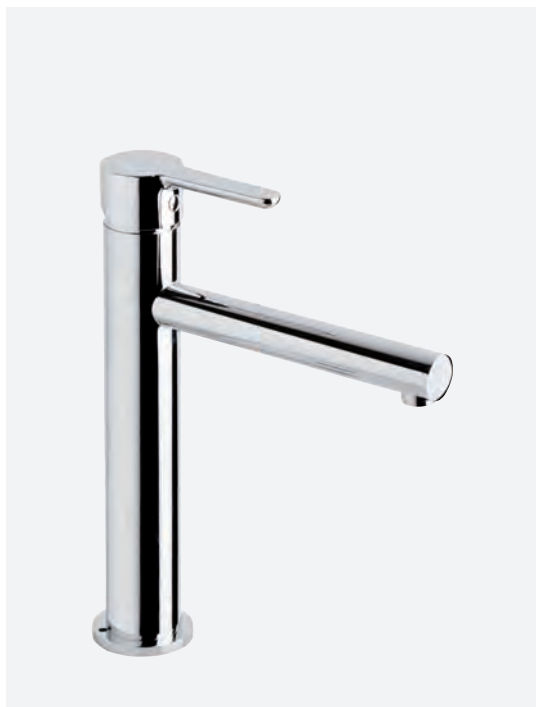

Ref.: 65134 19 45 66
Monomando de lavabo medio alto
Medium high single lever wash-basin mixer.
Cartucho 2 posiciones | 2-position cartridge



Ref.: 65136 19 45 66
Monomando de lavabo alto
High single lever wash-basin mixer
Cartucho 2 posiciones | 2-position cartridge

Oslo Lavabo empotrado | *Built-in single lever wash-basin mixers*



Ref.: 65131 19 45 66
Monomando de lavabo empotrado caño 16cm
Built-in wash-basin mixer 16 cm spout



Ref.: 65132 19 45 66
Monomando de lavabo empotrado caño 22cm
Built-in wash-basin mixer 22 cm spout

Oslo Monomando bidé | *Single lever bidet mixers*



Ref.: 65140 19 45 66
 Monomando de bidé
Single lever bidet mixer



Ref.: 65142 19 45 66
 Monomando de bidé con transmisión
Single lever bidet mixer with diverter

Oslo Baño y ducha | *Bath & shower*



Ref.: 65100 19 45 66
 Monomando de baño con kit
Single lever bath mixer with kit



Ref.: 65110 19 45 66
 Monomando de ducha con kit
Single lever shower mixer with kit



Ref.: 100197 45 00
 Mango de ducha C1 jet (bolsa)
C1 jet handshower (bag)
Ref.: 100135 60 00
 Flexo 1,70 m inoxidable
Stainless steel flexible hose 1.70 m
Ref.: 100153 45
 Soporte de ducha cilíndrico
Cylindrical shower holder

Oslo Empotrados | *Built-in single lever mixer*



Ref.: 65115 19 45 66
Monomando de ducha empotrado
Built-in single lever shower mixer



Ref.: 65116 19 45 66
Monomando de baño empotrado con inversor
Built-in single lever bath mixer with diverter

Oslo Style Shower



Ref.: 65116 19 45 66
Monomando de baño empotrado con inversor
Built-in single lever bath mixer with diverter

Ref.: B65113 18
Brazo pared redondo 35 cm
Round arm 35 cm

Ref.: R65112 18
Rociador redondo 22 cm
Round shower head Ø 22 cm

Ref.: 1636 45
Barra ducha TAU (caja)
TAU shower bar (box)

Ref.: 1680 04
Toma ducha mural redonda
Round flexible wall connector

Ref.: 100137 60 00
Flexo extensible 1,70 - 2,25 m inoxidable doble grapaje
*Extensible double lock stainless steel flexible hose
1.7-2.25 m*

Ref.: DXT3 45
Mango de ducha T3 jets (caja)
T3 jets handshower (box)

Oslo Cocina | Kitchen



Ref.: 65203 19 45 66
Monomando de fregadera
Single lever sink mixer



Ref.: 65192 19 45 66
Monomando de fregadera mural 15 cm
Wall single lever sink mixer 15 cm



Klip

Acabado cromado. Cartucho 40 | *Chromed finish. Cartridge 40*

SIEMPRE ACTUAL

De líneas rectas y casi cuadradas ofrece un diseño sugerente que se integra con las tendencias de decoración de las cocinas y baños más modernos. Robusta, resistente y de belleza discreta, la colección Klip es una de nuestras colecciones más solicitadas.

ALWAYS UP TO DATE

Straight, almost square lines offer a suggestive design that combines with the most modern decoration trends for kitchens and bathrooms. Robust, and resistant in its discreet beauty, the Klip series is one of our most sought after collections.



Klip Monomando Lavabo | *Single lever wash-basin mixer*



Ref.: 64130 16 45 66
Monomando de lavabo
Single lever wash-basin mixer
Cartucho 2 posiciones | 2-position cartridge



Ref.: 64134 16 45 66
Monomando de lavabo medio alto
Medium high single lever wash-basin mixer
Cartucho 2 posiciones | 2-position cartridge



Ref.: 64136 16 45 66
Monomando de lavabo alto
High single lever wash-basin mixer
Cartucho 2 posiciones | 2-position cartridge

Klip Lavabo empotrado | *Built-in single lever wash-basin mixer*



Ref.: 64131 16 45 66
Monomando de lavabo empotrado caño 16 cm.
Built-in wash-basin mixer 16 cm spout



Ref.: 64132 16 45 66
Monomando de lavabo empotrado caño 22 cm.
Built-in wash-basin mixer 22 cm spout

Klip Monomando Bidé | *Single lever bidet mixer*



Ref.: 64140 16 45 66
 Monomando de bidé
Single lever bidet mixer



Ref.: 64142 16 45 66
 Monomando de bidé con transmisión
Single lever bidet mixer with diverter

Klip Baño y ducha | *Bath & shower*



Ref.: 64100 16 45 66
 Monomando de baño con kit
Single lever bath mixer with kit



Ref.: 64110 16 45 66
 Monomando de ducha con kit
Single lever shower mixer with kit



Ref.: 100197 45 00
 Mango de ducha. C1 jet (bolsa)
Shower handle. C1 jet handshower (bag)

Ref.: 100135 60 00
 Flexo 1,70m inoxidable
Stainless steel flexible hose 1.70m

Ref.: 100153 45
 Soporte de ducha cilíndrico
Cylindrical shower holder

Klip Empotrados | *Built-in single lever bath & shower*



Ref.: 64115 16 45 66
Monomando de ducha empotrado
Built-in single level shower mixer



Ref.: 64116 16 45 66
Monomando de baño empotrado con inversor
Built-in single lever bath with diverter

Klip Termostática | *Thermostatic mixers*



Ref.: 67103 14 45 67
Termostática baño
Thermostatic bath mixer



Ref.: 67104 14 45 67
Termostática ducha
Thermostatic shower mixer

Klip Style shower



Ref.: 64116 16 45 66
 Monomando de baño empotrado con inversor
Built-in single lever bath mixer with diverter

Ref.: 1671 45
 Brazo a techo redondo 15 cm
Round roof arm 15 cm

Ref.: R65112 18
 Rociador redondo 22 cm
Round shower head Ø 22 cm

Ref.: 1680 04
 Toma ducha mural redonda
Round flexible wall connector

Ref.: 1748 45
 Conjunto Tau, barra, flexo y ducha 5 jets (caja)
Tau set, bar, hose and 5 jets handshower (box)



Ref.: 67103 14 45 67
 Termostática baño
Thermostatic bath mixer

Ref.: 1745 45
 Set columna extensible con ducha, soporte y flexo
Extensible column set with shower, holder and flexible hose

Klip Cocina | Kitchen



Ref.: 64192 16 45 66
Monomando de fregadera mural
Wall single lever sink mixer



Ref.: 64201 16 45 66
Monomando de fregadera
Single lever sink mixer



Ref.: 64206 16 45 66
Monomando de fregadera ducha extraíble
Single lever sink mixer with pull-out spray



Klip 2

Acabado cromado. Cartucho 40 | *Chromed finish. Cartridge 40*

UN TOQUE DE LIGEREZA

Para los que les gusta la elegancia de la colección Klip pero prefieren un diseño más ligero, Genebre ha creado la serie Klip2, con la maneta abierta. Grifos más estilizados y esbeltos que se convierten en una pieza clave para esta temporada.

A TOUCH OF LIGHTNESS

For those that like the elegance of the Klip collections, yet prefer a lighter design, Genebre has created the Klip2 series, with a cut-out design in the handle. More stylized and slender, it is a key piece for this season.



Klip 2 Monomando Lavabo | *Single lever wash-basin mixers*

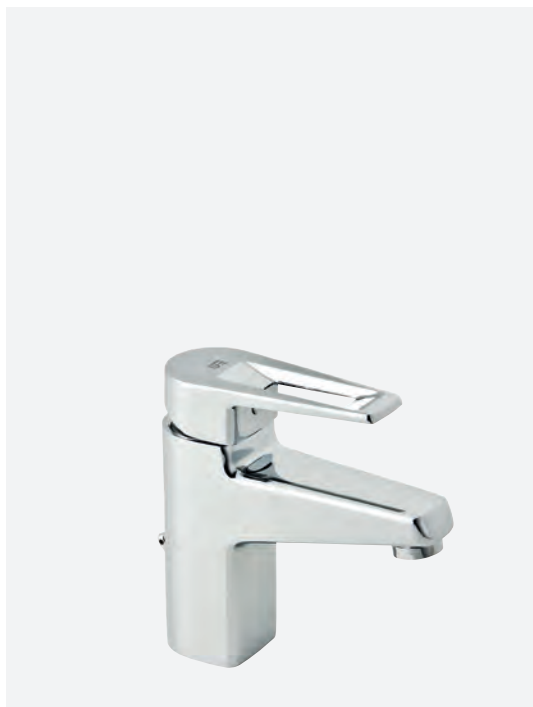

Ref.: 64130 14 45 66
Monomando de lavabo
Single lever wash-basin mixer
Cartucho 2 posiciones | 2-position cartridge



Ref.: 64134 14 45 66
Monomando de lavabo medio alto
Medium high single lever wash-basin mixer
Cartucho 2 posiciones | 2-position cartridge



Ref.: 64136 14 45 66
Monomando de lavabo alto
High single lever wash-basin mixer
Cartucho 2 posiciones | 2-position cartridge

Klip 2 Lavabo empotrado | *Built-in single lever wash-basic mixer*



Ref.: 64131 14 45 66
Monomando de lavabo empotrado caño 16 cm.
Built-in wash-basin mixer 16 cm spout



Ref.: 64132 14 45 66
Monomando de lavabo empotrado caño 22 cm.
Built-in wash-basin mixer 22 cm spout

Klip 2 Monomando bidé | *Single lever bidet mixer*



Ref.: 64140 14 45 66
 Monomando de bidé
Single lever bidet mixer



Ref.: 64142 14 45 66
 Monomando de bidé con transmisión
Single lever bidet mixer with diverter

Klip 2 Baño y ducha | *Bath & shower*



Ref.: 64100 14 45 66
 Monomando de baño con kit
Single lever bath mixer with kit



Ref.: 64110 14 45 66
 Monomando de ducha con kit
Single lever shower mixer with kit



Ref.: 100197 45 00
 Mango de ducha C1 jet (bolsa)
C1 jet handshower (bag)
Ref.: 100135 60 00
 Flexo 1,70m inoxidable
Stainless steel flexible hose 1.70m
Ref.: 100153 45
 Soporte de ducha cilíndrico
Cylindrical shower holder

Klip 2 Empotrados | *Built-in single lever bath & shower mixers*



Ref.: 64115 14 45 66
Monomando de ducha empotrado
Built-in single lever shower mixer



Ref.: 64116 14 45 66
Monomando de baño empotrado con inversor
Built-in single lever bath mixer with diverter

Klip 2 Cocina | *Kitchen*



Ref.: 64201 14 45 66
Monomando de fregadera
Single lever sink mixer



Ref.: 64206 14 45 66
Monomando de fregadera ducha extraíble
Single lever sink mixer with pull-out spray



Kelogic

Acabado cromado. Cartucho 40 | *Chromed finish. Cartridge 40*

AHORRA AGUA, AHORRA ENERGÍA

Innovación, tecnología y responsabilidad medioambiental se fusionan en la serie más ecológica de su gama. Su innovador sistema de apertura en frío que ayuda a ahorrar agua y energía la hace totalmente sostenible. Además, es muy cómoda porque el caudal se regula con mayor facilidad. Una colección ideal para el nuevo estilo de vida.

SAVE WATER, SAVE ENERGY

Innovation, technology and environmental responsibility merge in the most ecological series of its range. The innovative cold opening system helps to save water and energy, making it totally sustainable. In addition, it is very comfortable because the flow is regulated much more easily. An ideal collection for a new style of life.



HOGARES
de estudio
Lourdes Chlot
SUBIRACHS
ECO
Lourdes Chlot
SUBIRACHS
IN THE EMIRATES
THE UNITED KINGDOM
Lourdes Chlot
SUBIRACHS
Lourdes Chlot
SUBIRACHS

HIDENFOE

Kelogic La serie más ecológica | *The most environmental-friendly series*

Apertura en frío, Kelogic

La principal característica es el ahorro de energía. Al abrir el grifo en su posición central, saldrá solo agua fría, el agua caliente no saldrá mientras no giremos la maneta hacia la izquierda. Nuestro sistema Kelogic evita que su caldera o calentador se ponga en marcha innecesariamente.

Cold start, Kelogic

The main advantage of this series is energy savings. When you open the tap from its central position only cold water is used, and hot water only flows when the level is moved to the left. Energy is saved because our Kelogic system switches on the water heater only when necessary.



Inversor y racor ducha metálico
Metallic shower diverter and adapter



Sistema anti retorno con limitador de caudal dinámico
Stop return valves with dynamic flow restrictor

Flexible de alta resistencia, con sistema "anti lock" y antibacteriano
High-resistant, flexible, antibacterial hose with anti-lock system

Cartucho Economizador 2 posiciones
2-position cartridge saver



Apertura en frío
Cold start

Atomizador economizador de agua
Spray water economizer

Kelogic Monomando Lavabo | *Single lever wash-basin mixers*



Ref.: 64130 04 45 66
Monomando de lavabo apertura en frío
Single lever wash-basin mixer cold start
Atomizador economizador | Economizer aerator
Cartucho 2 posiciones | 2-position cartridge



Ref: 64134 04 45 66
Monomando lavabo medio alto apertura en frío
Medium high single lever wash-basin mixer cold start
Atomizador economizador | Economizer aerator
Cartucho 2 posiciones | 2-position cartridge



Ref: 64136 04 45 66
Monomando lavabo alto apertura en frío
High single lever wash-basin mixer cold start.
Atomizador economizador | Economizer aerator
Cartucho 2 posiciones | 2-position cartridge

Kelogic Monomando Bidé | *Single lever bidet mixer*



Ref: 64140 04 45 66
Monomando bidé apertura en frío
Single lever bidet mixer, cold start
Cartucho 2 posiciones | 2-position cartridge



Ref.: 64142 16 45 66
Monomando de bidé con transmisión
Single lever bidet mixer with diverter

Kelogic Baño y ducha | *Bath & shower*



Ref.: 64100 04 45 66

Monomando de baño con kit
Single lever bath mixer with kit

**Función ducha con antiretorno economizador | Economizer
stop return shower function**



Ref.: 64110 04 45 66

Monomando de ducha con set
Single lever shower mixer with kit

**Función ducha con antiretorno economizador | Economizer
stop return shower function**



Ref.: 100197 45 00

Mango de ducha C1 jet (bolsa)
Shower handle C1 jet handshower (bag)

Ref.: 100135 60 00

Flexo 1,70m inoxidable
Stainless steel flexible hose 1.70m

Ref.: 100153 45

Soporte de ducha cilíndrico
Cylindrical shower holder

Ref.: 100140 30

Flexo 1,70 m PVC antirotura y tuerca loca
*PVC flexible hose 1.70 m anti-breaking and swiveling
nut*

Kelogic Empotrado | *Built-in single lever bath & shower mixers*



Ref.: 64115 16 45 66

Monomando ducha empotrado
Built-in single lever shower mixer



Ref.: 64117 04 45 66

Monomando empotrado con inversor cerámico 2 vías
Built-in single handle mixer with 2-way ceramic diverter



Ref.: 64118 04 45 66

Monomando empotrado con inversor cerámico 3 vías
Built-in single handle mixer with 3-way ceramic diverter

Kelogic Cocina | kitchen



Ref.: 64201 04 45 66

Monomando de fregadera apertura frio
Single lever sink mixer cold start

Atomizador economizador | Economizer aerator

Cartucho 2 posiciones | 2-position cartridge

Kelogic Comparativas | Comparison

Comparativa consumo l/min. lavabo o bidé estandar versus su equivalente en Kelogic
Consumption comparison: l/min. standard wash basin or bidet

	Kelogic 1ª p .	Kelogic 2ª p	Grifo estandar/ Standard tap
1 bar	2,6	3,8	6,0
2 bar	4,3	6,2	9,6
3 bar	5,8	8,1	12,3
4 bar	6,8	9,6	14,0

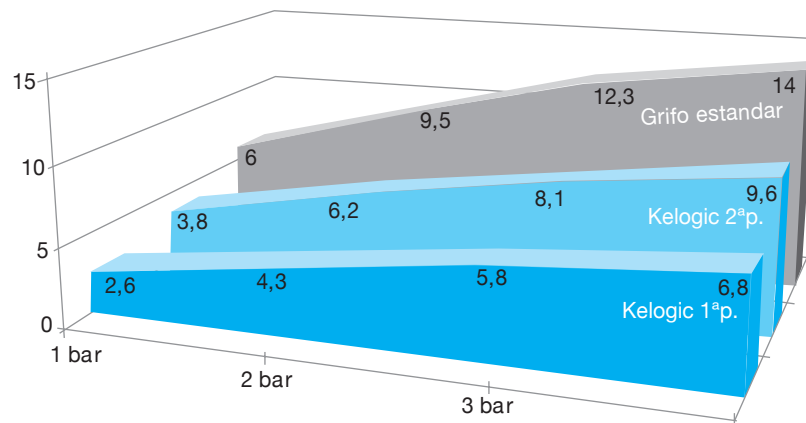

Comparative consumo l/min ducha estándar versus su equivalente en Kelogic
Consumption comparison: l/min. standard bath vs. Kelogic model

	Grifo estandar Standard tap	Kelogic	Ahorro Savings
1 bar	7,0	3,4	3,7
2 bar	11,0	5,0	6,0
3 bar	13,5	5,9	7,6
4 bar	16,6	6,9	9,6

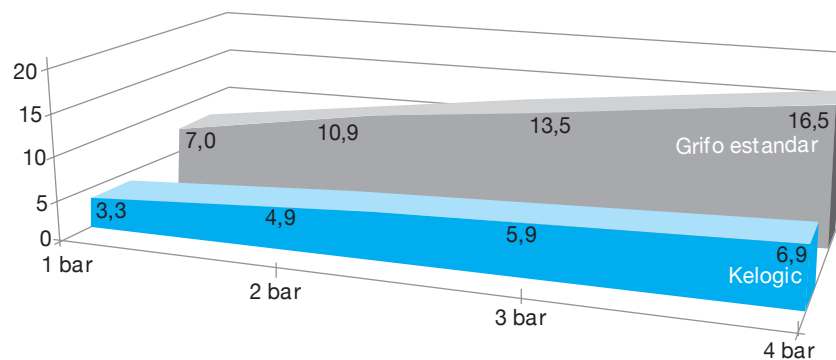

Tau

Acabado cromado. Cartucho 40 | *Chromed finish. Cartridge 40*

ESPACIOS CON CARÁCTER

Bella y seductora, la serie Tau transforma la cocina y el baño en espacios con estilo. Concebida a partir de un concepto de líneas cilíndricas y curvas estilizadas que realzan su silueta, cuenta con una gran gama de versiones que permiten adaptarla a todos los ambientes.

SPACES WITH CHARACTER

Beautiful and seductive, the Tau series transforms the kitchen and bathroom into spaces with style. Conceived from cylindrical lines and stylized curves that highlight its silhouette, there is a large variety that adapts to all types of ambiances.



Tau Monomando Lavabo | *Single lever wash-basin mixers*



Ref.: 65135 18 45 66
Monomando de lavabo
Single lever wash-basin mixer



Ref.: 65134 18 45 66
Monomando de lavabo medio alto
Medium height single lever wash-basin mixer



Ref.: 65136 18 45 66
Monomando de lavabo alto
High single lever wash-basin mixer

Tau Lavabo empotrado | *Built-in single lever wash-basin mixers*



Ref 65138 18 45 66
Monomando de lavabo
Single lever wash-basin mixer



Ref.: 65131 18 45 66
Monomando de lavabo empotrado caño 16cm
Built-in wash-basin mixer 16 cm spout



Ref.: 65132 18 45 66
Monomando de lavabo empotrado caño 22cm
Built-in wash-basin mixer 22 cm spout

Tau Monomando bidé | *Single lever bidet mixers*



Ref.: 65145 18 45 66
 Monomando de bidé
Single lever bidet mixer



Ref.: 65142 18 45 66
 Monomando de bidé con transmisión
Single lever bidet mixer with diverter

Tau Baño y ducha | *Bath & shower*



Ref.: 65100 18 45 66
 Monomando de baño con kit
Single lever bath mixer with kit



Ref.: 65110 18 45 66
 Monomando de ducha con kit
Single lever shower mixer with kit



Ref.: 100197 45 00
 Mango de ducha C1 jet (bolsa)
C1 jet handshower (bag)
Ref.: 100135 60 00
 Flexo 1,70 m inoxidable
Stainless steel flexible hose 1.70 m
Ref.: 100153 45
 Soporte de ducha cilíndrico
Cylindrical shower holder

Tau Empotrados | *Built-in single lever bath & shower mixers*



Ref.: 65115 18 45 66
Monomando de ducha empotrado
Built-in single lever shower mixer



Ref.: 65116 18 45 66
Monomando de baño empotrado con inversor
Built-in single lever bath mixer with diverter

Tau Empotrados | *Built-in single lever bath & shower mixers*



Ref.: 65117 18 45 66
Monomando empotrado con inversor cerámico 2 vías
Built-in single handle mixer with 2-way ceramic diverter



Ref.: 65118 18 45 66
Monomando empotrado con inversor cerámico 3 vías
Built-in single lever mixer with 3-way ceramic diverter

Tau Inversor | *Diverter*



Ref.: 65114 30 45 66
Inversor cerámico 3 vías empotrado con placa cuadrada
Built-in 3-way ceramic diverter with square plate

Tau Termostática | *Thermostatic mixers*



Ref.: 67102 14 45 67
Termostática baño
Thermostatic bath mixer



Ref.: 67112 14 45 67
Termostática ducha
Thermostatic shower mixer

Tau Termostática empotrada | *Built-in thermostatic mixers*



Ref.: 64113 14 45 67
Termostática empotrada 1 salida
Built-in thermostatic mixer 1 outlet

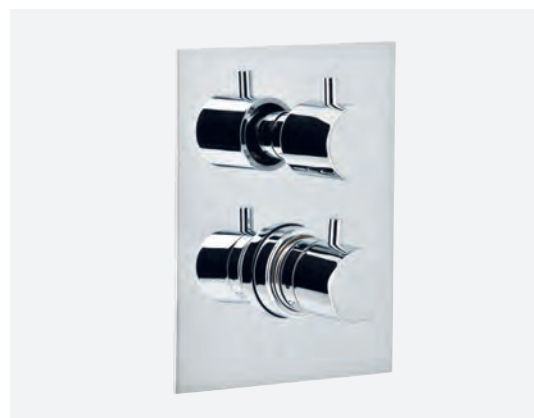

Ref.: 64114 14 45 67
Termostática empotrada 2 salidas
Built-in thermostatic mixer 2-outlets

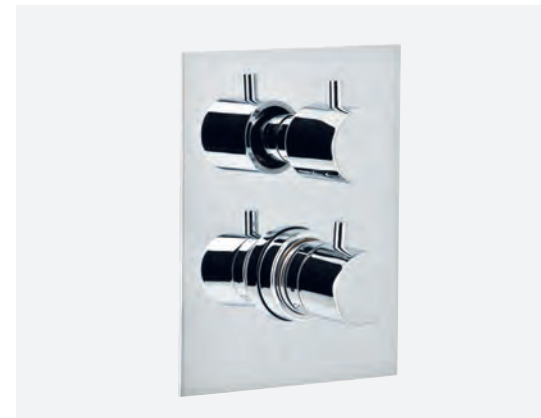

Ref.: 64111 14 45 67
Termostática empotrada 3 salidas
Built-in thermostatic mixer 3 outlets

Tau Columna | Columns



Ref.: CM65110 18
Columna monomando extensible con kit
Single lever extensible column with kit



Ref.: CT67110 18
Columna termostática extensible con kit
Thermostatic extensible column with kit



Ref.:1745 45
Set columna extensible con ducha, soporte y flexo
Extensible column set with shower, bracket and flexible hose



Tau Cocina | Kitchen



Ref.: 65204 18 45 66
Monomando de fregadera
Single lever sink mixer



Ref.: 65203 18 45 66
Monomando de fregadera
Single lever sink mixer



Ref.: FRT65401
Monomando de fregadera cartucho 25
Single lever sink mixer cartridge 25

Tau Cocina | Kitchen



Ref.: FRT65402
Monomando de fregadera cartucho 35
Single lever sink mixer 35 cartridge



Ref.: 65702 18 45 66
Monomando de fregadera Osmosis cartucho 35
Osmosis single lever sink mixer 35 cartridge



Ref.: 65900 18 45 66
Monomando de fregadera abatible cartucho 35
Folding single lever sink mixer 35 cartridge

Tau Cocina | Kitchen



Ref.: 65206 18 45 66
Monomando de fregadera caño extraíble
Single lever sink mixer with pull-out spout



Ref.: 65205 18 45 66
Monomando de fregadera ducha extraíble
Single lever sink mixer with pull-out spray

Tau Cocina | Kitchen



Ref.: FRV61205
Monomando de fregadera ducha extraíble
Single lever sink mixer with pull-out spray



Ref.: FRV61206
Monomando de fregadera caño extraíble
Single-lever sink mixer with pull-out spout



Ref.: 65192 18 45 66
Monomando de fregadera mural 15 cm
Wall single lever sink mixer 15 cm

Tau 2

Acabado cromado. Cartucho 40 | *Chromed finish. Cartridge 40*

MEZCLA DE FORMAS

Una colección con mucha personalidad que se sumerge en el contraste de las formas. El caño cilíndrico que proviene de la serie TAU convive con una maneta de formas totalmente rectas. Una fusión que aporta a esta colección un aire más actual.

MIXTURE OF FORMS

A collection with a lot of personality is immersed in the contrast of forms. The cylindric spout that comes from the TAU series co-exists with a handle with totally straight lines. A fusion that contributes an air of modernity to the collection.



Tau 2 Monomando Lavabo | *Single lever wash-basin mixers*



Ref.: 65135 29 45 66
Monomando de lavabo
Single lever wash-basin mixer



Ref.: 65134 29 45 66
Monomando de lavabo medio alto
Medium height single lever wash-basin mixer



Ref.: 65136 29 45 66
Monomando de lavabo alto
High single lever wash-basin mixer

Tau 2 Lavabo empotrado | *Built-in single lever wash-basin mixers*



Ref.: 65131 29 45 66
Monomando de lavabo empotrado caño 16cm
Built-in wash-basin mixer 16 cm spout



Ref.: 65132 29 45 66
Monomando de lavabo empotrado caño 22cm
Built-in wash-basin mixer 22 cm spout

Tau 2 Monomando bidé | *Single lever bidet mixers*



Ref.: 65145 29 45 66
 Monomando de bidé
Single lever bidet mixer



Ref.: 65142 29 45 66
 Monomando de bidé con transmisión
Single lever bidet mixer with diverter

Tau 2 Baño y ducha | *Bath & shower*



Ref.: 65100 29 45 66
 Monomando de baño con kit
Single lever bath mixer with kit



Ref.: 65110 29 45 66
 Monomando de ducha con kit
Single lever shower mixer with kit



Ref.: 100197 45 00
 Mango de ducha C1 jet (bolsa)
SC1 jet hansshower (bag)
Ref.: 100135 60 00
 Flexo 1,70m inoxidable
Stainless steel flexible hose 1.70m
Ref.: 100153 45
 Soporte de ducha cilíndrico
Cylindrical shower holder

Tau 2 Empotrados | *Built-in single lever bath & shower mixers*



Ref.: 65115 29 45 66
Monomando de ducha empotrado
Built-in single lever shower mixer



Ref.: 65116 29 45 66
Monomando de baño empotrado con invector
Built-in single lever bath mixer with diverter

Tau 2 Columna | *Column*



Ref.: CM65110 29
Columna monomando extensible con kit
Single lever extensible column with kit



Kenjo

Acabado cromado. Cartucho 35 | *Chromed finish. Cartridge 35*

CREADA PARA SENTIR EL PLACER DEL AGUA

Diseño de gran belleza minimalista, con cuidadas formas rectas y una minuciosa atención a los detalles la convierten en una gama muy especial. Elegante y sobria, pero a la vez espectacular. La salida del agua es libre o tipo cascada que proporciona un chorro limpio y natural para disfrutar de momentos de intenso placer.

CREATED TO FEEL THE PLEASURE OF WATER

A design with great minimalist beauty, careful straight lines, and a meticulous attention to detail make it a very special range. Elegant and simple, yet spectacular at the same time. The water outlet is free or waterfall-style and gives a clean and natural stream to enjoy the pleasures of water.



GENÈRE

Kenjo Monomando Lavabo | *Single lever wash-basin mixers*



Ref.: 63130 26 45 66
Monomando de lavabo
Single lever wash-basin mixer



Ref.: 63134 26 45 66
Monomando de lavabo medio alto
Medium height single lever wash-basin mixer



Ref.: 63136 26 45 66
Monomando de lavabo alto
High single lever wash-basin mixer

Kenjo Lavabo cascada | *Waterfall single lever wash-basin mixers*



Ref.: 63137 26 45 66
Monomando de lavabo cascada
Waterfall single lever wash-basin mixer



Ref.: 63138 26 45 66
Monomando de lavabo cascada alto
High waterfall single lever wash-basin mixer



Kenjo Lavabo empotrado | *Built-in single lever wash-basin mixers*



Ref.: 63131 26 45 66
Monomando de lavabo empotrado caño 16cm
Built-in wash-basin mixer 16 cm spout



Ref.: 63132 26 45 66
Monomando de lavabo empotrado caño 22cm
Built-in wash-basin mixer 22 cm spout

Kenjo Monomando bidé | *Single lever bidet mixer*



Ref.: 63140 26 45 66
Monomando de bidé
Single lever bidet mixer



Ref.: 63142 26 45 66
Monomando de bidé con transmisión
Single lever bidet mixer with diverter

Kenjo Baño y Ducha | *Bath & shower*



Ref.: 63100 26 45 67
 Monomando de baño sin kit
Single lever bath mixer without kit



Ref.: 63110 26 45 67
 Monomando de ducha sin kit
Single lever shower mixer without kit



Ref.: DXK3 45
 Mango de ducha K3 jets (caja)
K3 jet handshower (box)
Ref.: 100135 60 00
 Flexo 1,70 m inoxidable
Stainless steel flexible hose 1.70 m
Ref.: 100149 45
 Soporte ducha Kenjo
Kenjo shower holder

Kenjo Empotrados | *Built-in single lever bath and shower mixers*



Ref.: 63115 26 45 66
 Monomando de ducha empotrado
Built-in single lever shower mixer



Ref.: 63116 26 45 66
 Monomando de baño empotrado con inversor
Built-in single lever bath mixer with diverter

Kenjo Termostática | *Thermostatic mixers*



Ref.: 67100 26 45 67
Termostática de baño sin kit
Thermostatic bath mixer without kit



Ref.: 67110 26 45 67
Termostática ducha sin kit
Thermostatic shower mixer without kit

Kenjo Cocina | *Kitchen*



Ref.: FRK63401
Monomando de fregadera cartucho 25
Single lever sink mixer 25 cartridge



Ref.: FRK63400
Monomando de fregadera cartucho 25
Single lever sink mixer 25 cartridge



Kenjo Columnas | Columns



Ref.: CM63110 26
Columna monomando extensible con kit
Single lever extensible column with kit



Ref.: CT67110 26
Columna termostática extensible con kit
Thermostatic extensible column with kit



Ref.: 1746 45
Set columna extensible con ducha, soporte y flexo
Extensible column set with shower, bracket and flexible hose

Inox

Acero Inoxidable. Cartucho 35 | *Stainless Steel. Cartridge 35*

AUTÉNTICA PASIÓN POR LA COCINA

La serie Inox está diseñada especialmente para el mundo de la cocina. Estilizada, funcional y fabricada con acero inoxidable que, además de proyectar un aspecto siempre limpio, le aporta elegancia y modernidad. Una serie imprescindible para las cocinas más actuales.

AN AUTHENTIC PASSION FOR COOKING

The Inox series is designed specially for the world of cooking. Stylized, functional and made with stainless steel, which, in addition to always giving a clean appearance, provides elegance and modernity. An essential series for the most up-to-date kitchens.



Inox Cocina | Kitchen



Ref.: 65211 18 60 66
Monomando de fregadera inox con muelle
Stainless steel single lever with spring



Ref.: 65207 18 60 66
Monomando de fregadera inox con muelle y ducha
extraíble
*Stainless steel single lever with spring and pull-out
sprayer*

Inox Cocina | Kitchen



Ref.: 65203 18 60 66
Monomando de fregadera inox caño cisne
Stainless steel single lever sink tap, with swan pipe



Ref.: 65208 18 60 66
Monomando de fregadera inox doble función Cubik
Stainless steel square single lever Cubik dual function



Ge2

Acabado cromado. Cartucho 40 | *Chromed finish. Cartridge 40*

LA GRANDEZA DE LO SENCILLO

Sencillez y dinamismo, de formas naturales y enérgicas son los atributos que definen esta sugerente colección. Sus líneas curvas y, a la vez, inclinadas y ergonómicas, su resistencia y su gran fiabilidad le otorgan un aspecto inconfundible.

THE GREATNESS OF THE SIMPLE

Simplicity and dynamism, with natural energetic forms, are the attributes that define this suggestive collection. Its curved and ergonomic lines, ireresistance and great reliability give it a striking appearance.



Ge2 Monomando lavabo | *Single lever wash-basin mixers*



Ref.: 61130 22 45 66
Monomando de lavabo Plus
Single lever wash-basin mixer Plus



Ref.: 60130 22 45 66
Monomando de lavabo
Single lever wash-basin mixer



Ref.: 60188 22 45 66
Monomando de lavabo centerset 4"
Single lever wash-basin mixer 4" centerset

Ge2 Monomando bidé | *Single lever bidet mixers*



Ref.: 60140 22 45 66
Monomando de bidé
Single lever bidet mixer



Ref.: 61142 22 45 66
Monomando de bidé con transmisión
Single lever bidet mixer with diverter

Ge2 Baño y ducha | Bath & shower



Ref.: 60100 22 45 66
 Monomando de baño con kit
Single lever bath mixer with kit



Ref.: 60110 22 45 66
 Monomando de ducha con kit
Single lever shower mixer with kit



Ref.: 100175 45 00
 Mango de ducha E1 jet
E1 jet handshower
Ref.: 100135 60 00
 Flexo 1,70 m inoxidable
Stainless steel flexible hose 1.70 m
Ref.: 100152 45
 Soporte de ducha Combi
Combi shower holder

Ge2 Empotrados | Built-in single lever bath & shower mixers



Ref.: 61115 22 45 66
 Monomando de ducha empotrado
Built-in single lever shower mixer



Ref.: 61116 22 45 66
 Monomando de baño empotrado con inversor
Built-in single lever bath mixer with diverter

Ge2 Style Shower



Ref.: 61116 22 45 66

Monomando de baño empotrado con inversor

Built-in single lever bath mixer with diverter

Ref.: 1698 45

Rociador ducha con brazo

Wall shower arm and spray

Ref.: 1667 45

Caño mural baño fundido

Casted wall bath spout

Ref.: 61116 22 45 66

Monomando de baño empotrado con inversor

Built-in single lever bath mixer with diverter

Ref.: B65113 18

Brazo pared redondo 35 cm

Round arm 35 cm

Ref.: R65112 18

Rociador redondo 22 cm

Round shower head Ø 22 cm

Ref.: 1638 45

Barra ducha redonda (caja)

Round shower bar (box)

Ref.: 1680 04

Toma ducha mural redonda

Round wall flexible connector

Ref.: DXE2 45

Mango de ducha E2 jets (caja)

E2 jets handshower (box)

Ref.: 100135 60 00

Flexo 1,70 m. inoxidable

Stainless steel flexible hose 1.70 m.

Ge2 Grifos 1 agua | *One-water taps*



Ref.: 1002 04
 Grifo lavabo 1 agua cartucho 25
One-water wash basin 25 cartridge



Ref.: 1003 04
 Grifo lavabo mural 1 agua cartucho 25
One-water wall wash basin 25 cartridge

Ge2 Fregaderas 1 agua | *One-water sink taps*



Ref.: 1008 04
 Grifo mural con tubo 24 cm 1 agua cartucho 25
One-water wall sink tap spout 24cm 25 cartridge



Ref.: 1009 04
 Grifo fregadera 1 agua cartucho 25
One-water sink tap 25 cartridge



Ref.: 1005 04
 Grifo mural con tubo alto 1 agua cartucho 25
One-water wall sink tap high spout 25 cartridge

Ge2 Grifos 1 agua | *One-water taps*



Ref.: 1023 04
Grifo doble combinable 1/2"-3/4" y 1/2"
Double outlet tap 1/2" - 3/4" and 1/2"



Ref.: 1024 04
Grifo doble combinable a 1/2" - 3/4" y atomizador
Double outlet tap 1/2" - 3/4" and aerator

Ge2 Teleducha bidé | *Bidet Shower*



Ref.: 60001 22 45 67
Grifo bide mural 1 agua cartucho 25
One water wall bidet 25 cartridge

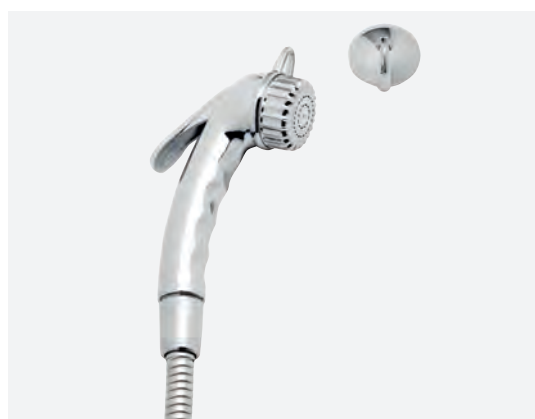

Ref.: 100141 45
Flexo 1,20 m inoxidable
Stainless steel flexible hose 1.20 m
Ref.: 100696 45
Kit soporte y teleducha bidé
Holder and bidet spray



Sigma

Acabado cromado. Cartucho 40 | *Chromed finish. Cartridge 40*

DISEÑADA PARA SIEMPRE

Inspirada en las formas de la naturaleza, busca la combinación de la simplicidad con una estética de líneas suaves y cálidas. Una unión perfecta para esta colección de cuerpo robusto y maneta armoniosa que busca ser una pieza siempre actual.

DESIGNED FOR FOREVER

Inspired in natural forms, the combination of simplicity with an aesthetic of soft warm lines. A perfect union for this collection with a robust body and harmonious handle, resulting in a piece always in style.



Sigma Monomando Lavabo | *Single lever wash-basin mixers*



Ref.: 61130 06 45 66
Monomando de lavabo Plus
Single lever wash-basin mixer Plus



Ref.: 60130 06 45 66
Monomando de lavabo
Single lever wash-basin mixer



Ref.: 60188 06 45 66
Monomando de lavabo centerset 4"
Single lever wash-basin mixer 4" centerset

Sigma Monomando bidé | *Single lever bidet mixers*



Ref.: 60140 06 45 66
Monomando de bidé
Single lever bidet mixer



Ref.: 61142 06 45 66
Monomando de bidé con transmisión
Single lever bidet mixer with diverter

Sigma Baño y ducha | Bath & shower



Ref.: 60100 06 45 66
 Monomando de baño con kit
Single lever bath mixer with kit



Ref.: 60110 06 45 66
 Monomando de ducha con kit
Single lever shower mixer with kit



Ref.: 100175 45 00
 Mango de ducha E1 jet (bolsa)
E1 jet handshower (bag)
Ref.: 100135 60 00
 Flexo 1,70 m inoxidable
Stainless steel flexible hose 1.70 m
Ref.: 100152 45
 Soporte de ducha Combi
Combi shower holder

Sigma Empotrados | Built-in single lever bath & shower mixers



Ref.: 61115 06 45 66
 Monomando de ducha empotrado
Built-in single lever shower mixer



Ref.: 61116 06 45 66
 Monomando de baño empotrado con inversor
Built-in single lever bath mixer with diverter

Sigma Style Shower



Ref.: 61116 06 45 66

Monomando de baño empotrado con inversor

Built-in single lever bath with diverter

Ref.: 1698 45

Rociador ducha con brazo

Wall shower arm and spray

Ref.: 1667 45

Caño mural baño fundido

Casted wall bath spout



Ref.: 61116 06 45 66

Monomando de baño empotrado con inversor

Built-in single lever bath with diverter

Ref.: 1698 45

Rociador ducha con brazo

Wall shower arm and spray

Ref.: 1638 45

Barra ducha redonda (caja)

Round shower bar (box)

Ref.: 1680 04

Toma ducha mural redonda

Round wall flexible connector

Ref.: 100135 60 00

Flexo 1,70 m. inoxidable

Ref.: DXE2 45

Mango de ducha E2 jets (caja)

E2 jets handshower (box)

Sigma Cocina | Kitchen



Ref.: 61201 06 45 66
Monomando de fregadera caño fundido
Single lever sink mixer casted spout



Ref.: 61203 06 45 66
Monomando de fregadera caño conformado
Single lever sink mixer tube spout



Ref.: 61210 06 45 66
Monomando de fregadera caño fundido
Single lever sink mixer casted spout

Sigma Cocina | Kitchen



Ref.: 61204 06 45 66
Monomando de fregadera caño conformado
Single lever sink mixer tube spout



Ref.: 61206 06 45 66
Monomando de fregadera ducha extraíble cromo
Single lever sink mixer with pull-out spray



Ref.: 61205 06 45 66
Monomando de fregadera ducha extraíble
Single lever sink mixer with pull-out spray

Sigma Cocina | Kitchen



Ref.: 61192 06 45 66
Monomando de fregadera mural 15 cm
Single lever wall sink mixer 15 cm



Ref.: 61190 06 45 66
Monomando de fregadera mural 15 cm caño corto
Wall single lever sink mixer 15cm short spout



Ref.: 61195 06 45 66
Monomando de fregadera mural 11 cm
Wall single lever sink mixer 11 cm

Sigma Cocina | Kitchen



Ref.: 61196 06 45 66
Monomando de fregadera caño inferior elevado
Wall single lever sink mixer low spout



Ref.: 61200 06 45 66
Monomando de fregadera
Single lever sink mixer



Ref.: 61900 06 45 66
Monomando de fregadera abatible
Single lever folding sink mixer

Sigma Cocina | Kitchen



Ref.: 60198 05 45 66
Monomando mesada 8"
8" widespread single lever sink mixer



Ref.:60199 05 45 66
Monomando mesada 6"
6" widespread single lever sink mixer



Ref.: 60194 05 45 66
Monomando de fregadera mural 8"
Wall single lever 8" sink mixer

Sigma Grifos 1 agua | One-water taps



Ref.: 1006 04
Grifo lavabo mural 1 agua cartucho 25
One-water wall wash-basin mixer 25 cartridge



Ref.: 1007 04
Grifo lavabo 1 agua cartucho 25
One-water wash-basin mixer 25 cartridge

New Regent Classic

Montura 1/4 vuelta cierre cerámico | *Ceramic headwork quarter turn*

GLAMOUR VINTAGE

La serie New Regent Classic readapta el estilo más clásico, y a veces de elegancia barroca, a los baños y cocinas de hoy. Un excelente y refinado maridaje de calidad, glamour y estilo vintage que nos transporta a épocas lejanas. Disponibles en acabados cromo o bronce.

VINTAGE GLAMOUR

The New Regent Classic series readapts a most classic style, almost baroque in elegance, to the bathrooms and kitchens of today. An excellent and refined blend of quality, glamour and vintage style that transports us to ancient times. Available in chrome and bronze finishes.



New Regent Classic Cromo | *Chromed*



Ref.: 68506 09 45 66
Monobloc de lavabo cromo
Chromed wash-basin mixer



Ref.: 68516 09 45 66
Monobloc de bidé cromo
Chromed bidet mixer

New Regent Classic Cromo | *Chromed*



Ref.: 68526 09 45 66
Mezclador de baño cromo con kit
Chromed bath mixer with kit



Ref.: 68531 09 45 66
Mezclador de ducha cromo con kit
Shower mixer chromed with kit



Ref.: 100196 45 00
Mango de ducha New Regent cromo
New Regent chromed hand shower
Ref.: 100135 60 00
Flexo H 1/2" - H 1/2" 170 cm
F 1/2" - F 1/2" 170 cm flexible hose
Ref.: 1649 45
Soporte ducha Clásico cromo
Chromed bath mixer with kit

New Regent Classic Bronce | *Bronze*



Ref.: 68506 09 43 66
Monobloc de lavabo bronce
Bronze bath mixer with kit



Ref.: 68516 09 43 66
Monobloc bidet bronce
Bronze bidet mixer

New Regent Classic Bronce | *Bronze*



Ref.: 68526 09 43 66
Mezclador de baño bronce con kit
Bronze bath mixer with kit



Ref.: 68531 09 43 66
Mezclador de ducha bronce con kit
Bronze shower mixer with kit

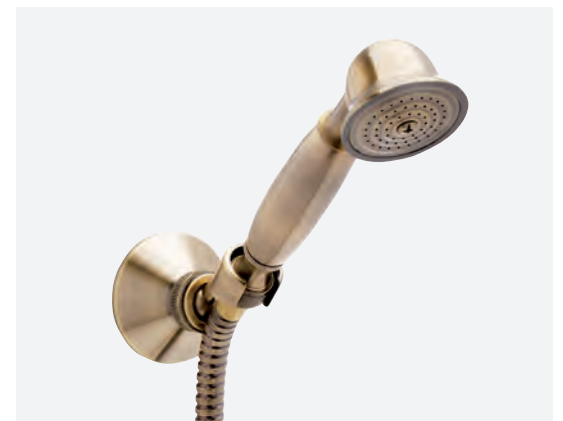

Ref.: 100196 43 00
Mango de ducha New Regent bronce
New Regent bronze hand shower
Ref.: 100135 43 00
Flexo H 1/2" - H 1/2" bronce 170 cm
F 1/2" - F 1/2" bronze 170 cm flexible hose
Ref.: 1649 43
Soporte ducha Clásico bronce
Classic bronze shower holder

New Regent Classic Cocina | *Kitchen*



Ref.: 68595 09 45 66
Monobloc de fregadera cromo
Sink mixer chromed



Ref.: 68595 09 43 66
Monobloc de fregadera bronce
Sink mixer bronze



Ref.: 68201 39 45 66
Monomando de fregadera cromo
Sink mixer chromed



New Regent

Acabado cromado. Montura 1/4 vuelta cierre cerámico | *Chromed finish. Ceramic headwork quarter turn*

DISTINCIÓN Y ELEGANCIA CLÁSICA

De líneas curvas y volantes en cruz, esta colección está impregnada del estilo vintage del modelo New Regent Classic. Insinuando el pasado, sus líneas más sencillas y evocadoras la convierten en una bella selección de grifos que aportan un toque de romanticismo al ambiente.

CLASSIC DISTINCTION AND ELEGANCE

With curved lines and cross handled wheels, this collection is permeated with full of vintage style from the New Regent Classic model. Insinuating the past, its simple and evocative lines makes it a beautiful selection of taps that add a touch of romanticism to the ambience.



New Regent Monobloc lavabo | *Wash-basin mixers*



Ref.: 68505 09 45 66
Monobloc de lavabo
Wash-basin mixer



Ref.: 68510 09 45 66
Bateria lavabo
Widespread wash-basin mixer



Ref.: 68120 09 45 66
Bateria lavabo
Widespread wash-basin mixer

New Regent Monobloc lavabo | *Wash-basin mixers*



Ref.: 68511 09 45 66
Mezclador lavabo centerset 4"
Wash-basin mixer 4" centerset



Ref.: 68500 09 45 66
Grifo lavabo
Wash-basin tap

New Regent Monobloc bidé | *Bidet mixers*



Ref.: 68515 09 45 66
Monobloc de bidé
Bidet mixer



Ref.: 68520 09 45 66
Grifo bidé
Bidet tap



Ref.: 68142 09 45 66
Batería de bidé con transmisión
Widespread bidet mixed with transmission

New Regent Baño y Ducha | *Bath & Shower mixers*



Ref.: 68525 09 45 66
Mezclador de baño con kit
Bath mixer with kit



Ref.: 68530 09 45 66
Mezclador de ducha con kit
Shower mixer with kit



Ref.: 100175 45 00
Mango de ducha E1 jet (bolsa)
E1 jet handshower (bag)
Ref.: 100135 60 00
Flexo 1,70 m inoxidable
Stainless steel flexible hose 1.70 m
Ref.: 100152 45
Soporte de ducha Combi
Combi shower holder

New Regent Empotrados | *Built-in mixers*



Ref.: 68131 09 45 66
Grupo de lavabo empotrado
Built-in wash basin



Ref.: 68535 09 45 66
Grupo ducha empotrado 8"
Built-in 8" shower mixer



Ref.: 68527 09 45 66
Grupo baño empotrado 8" con inversor
Built-in 8" bath mixer with diverter

N.R. Llave de paso | *Stopcock*



Ref.: 68590 09 45 66
Llave de paso 1/2"
Stopcock 1/2"

New Regent TeleDucha | *Bidet shower*

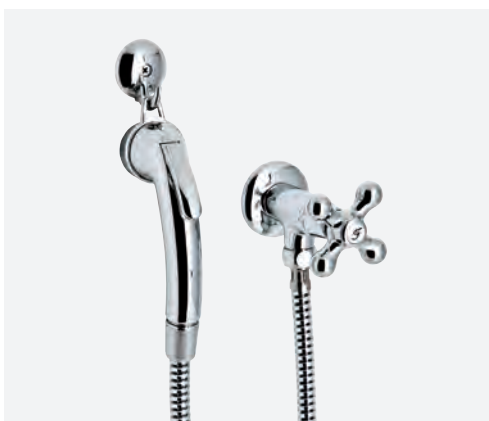

Ref.: 68001 09 45 66
Grifo de bide con teleducha
Bidet tap with shower

New Regent Cocina | Kitchen



Ref.: 68540 09 45 66
Monobloc fregadera caño tubo
Sink mixer, goose neck spout



Ref.: 68550 09 45 66
Grupo mural fregadera 11 cm caño tubo alto 18cm
Wall sink mixer, 11 cm high tube, 18cm spout



Ref.: 68196 09 45 66
Grupo mural fregadera 11 cm caño tubo alto 24cm
Wall sink mixer, 11 cm high tube, 24 cm spout

New Regent Cocina | Kitchen



Ref.: 68555 09 45 66
Grupo mural fregadera 15 cm caño tubo alto 24cm
Wall-mounted sink mixer, 15 cm with 24 cm high tube spout



Ref.: 68560 09 45 66
Grupo mural fregadera 15cm caño tubo bajo 24cm
Wall-mounted sink mixer, 15 cm with 24 cm low tube spout



Ref.: 68565 09 45 66
Grupo mural fregadera 20 cm caño tubo alto 24cm
Wall-mounted sink mixer, 20 cm with 24 cm high tube spout

New Regent Cocina | Kitchen



Ref.: 68570 09 45 66

Grupo mural fregadera 20 cm caño tubo alto vertical
Wall sink mixer with 20cm swan neck spout



Ref.: 68194 09 45 66

Mezclador mesada 6" caño tubo
Top mixer with 6" swan neck spout



Ref.: 68545 09 45 66

Mezclador mesada 8" caño tubo
Top mixer with 8" swan neck spout

New Regent Cocina | Kitchen



Ref.: 68580 09 45 66

Grifo mural fregadera caño tubo alto 24cm
Wall sink tap with 24cm tube spout



Ref.: 68585 09 45 66

Grifo fregadera vertical caño tubo
Sink tap with tube spout



Ref.: 68575 09 45 66

Grifo fregadera mural caño tubo vertical
Wall sink tap with goose neck spout

New Regent Cocina | Kitchen



Ref.: 568550 45
Cuerpo grupo mural 11 cm
Wall mixer 11 cm



Ref.: 568555 45
Cuerpo grupo mural 15cm
Wall mixer 15 cm

New Regent Cocina | Kitchen



Ref.: 568565 45
Cuerpo grupo mural 20cm
Wall mixer 20 cm



Ref.: 568575 45
Cuerpo grifo mural
Wall tap

New Regent Cocina | Kitchen



Ref.: 68901 45
Caño alto tubo 18 cm
High tube spout 18 cm
Ref.: 68902 45
Caño alto tubo 24 cm
High tube spout 24 cm
Ref.: 68908 45
Caño alto tubo 30 cm
High tube spout 30 cm



Ref.: 68910 45
Caño bajo tubo 18 cm
Low tube spout 18 cm
Ref.: 68904 45
Caño bajo tubo 24 cm
Low tube spout 24 cm
Ref.: 68909 45
Caño bajo tubo 30 cm
Low tube spout 30 cm



Ref.: 68903 45
Caño tubo vertical
Swan neck spout

Gamma

Acabado cromado. Montura convencional | *Chromed finish. Conventional headwork*

DISCRECIÓN INTENCIONADA

Sencilla y discreta. Ideal para aquellos espacios que buscan funcionalidad. De estilo bimando y características clásicas, los grifos de esta serie ofrecen un excelente equilibrio entre su diseño sereno y la alta calidad.

INTENTIONAL DISCRETION

Simple and discreet. Ideal for those spaces seeking functionality. With dual handles and classic features, the taps in this series offer an excellent balance between their serene design and high quality.



Gamma Monobloc lavabo | *Wash-basin mixers*



Ref.: 68130 11 45 66
Monobloc de lavabo
Wash-basin mixer



Ref.: 68120 11 45 66
Bateria de lavabo
Widespread wash-basin mixer

Gamma Monobloc lavabo | *Wash-basin mixers*



Ref.: 68122 11 45 66
Mezclador lavabo centerset 4"
Wash-basin mixer 4" centerset



Ref.: 68180 11 45 66
Grifo de lavabo
Wash-basin tap

Gamma Monobloc bidé | Bath & Shower



Ref.: 68140 11 45 66
Monobloc de bidé
Bidet mixer



Ref.: 68160 11 45 66
Grifo bidé
Bidet tap



Ref.: 68142 11 45 66
Batería de bidé con transmisión
Widespread bidet mixer with transmission

Gamma Baño y Ducha | Bath & Shower mixer



Ref.: 68100 11 45 66
Mezclador de baño con kit
Bath mixer with kit



Ref.: 68110 11 45 66
Mezclador de ducha con kit
Shower mixer with kit

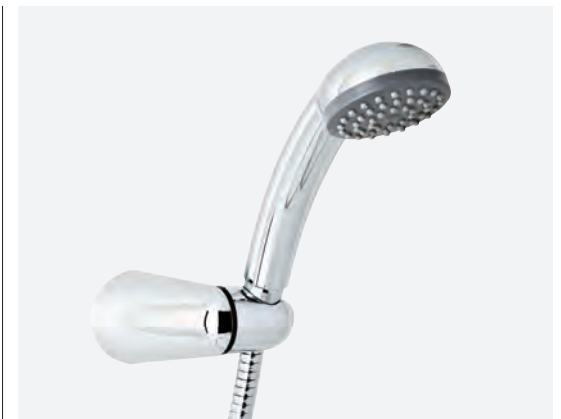

Ref.: 100175 45 00
Mango de ducha E1 jet (bolsa)
E1 jet handshower (bag)
Ref.: 100135 60 00
Flexo 1,70 m inoxidable
Stainless steel flexible hose 1.70 m
Ref.: 100152 45
Soporte de ducha Combi
Combi shower holder

Gamma Empotrados | Built-in mixers



Ref.: 68131 11 45 66
Grupo de lavabo empotrado
Built-in wash basin



Ref.: 68115 11 45 66
Grupo ducha empotrado 8"
Built-in 8" shower mixer



Ref.: 68116 11 45 66
Grupo baño empotrado 8" con inversor
Built-in 8" bath mixer with diverter

Gamma Llave de paso | Stopcock



Ref.: 68170 11 45 66
Llave de paso 1/2"
Stopcock 1/2"

Gamma Teleducha bidé | Bidet shower



Ref.: 68001 11 45 66
Grifo de bide con teleducha
Bidet tap with shower

Gamma Cocina | Kitchen



Ref.: 68200 11 45 66
 Monobloc de fregadera caño tubo
Sink mixer swan neck spout



Ref.: 68195 11 45 66
 Grupo mural fregadera 11 cm caño tubo alto 18cm
Wall sink mixer, 11 cm with 18 cm high tube spout



Ref.: 68196 11 45 66
 Grupo mural fregadera 11 cm caño tubo alto 24cm
Wall sink mixer, 11 cm with 24 cm high tube spout

Gamma Cocina | Kitchen



Ref.: 68190 11 45 66
 Grupo mural fregadera 15 cm caño tubo alto 18cm
Wall sink mixer, 15 cm with 18 cm high tube spout



Ref.: 68193 11 45 66
 Grupo mural fregadera 15 cm caño tubo alto 24cm
Wall sink mixer, 15 cm with 24 cm high tube spout



Ref.: 68197 11 45 66
 Grupo mural fregadera 15cm caño tubo bajo 24cm
Wall sink mixer, 15cm with 24 cm low tube spout

Gamma Cocina | *Kitchen*



Ref.: 68103 11 45 66

Grupo mural fregadera 20 cm caño tubo alto vertical
Wall sink mixer, 20 cm swan neck spout



Ref.: 68104 11 45 66

Grupo mural fregadera 20 cm caño tubo alto 24cm
Wall sink mixer, 20 cm with 24 cm high tube spout

Gamma Cocina | *Kitchen*



Ref.: 68093 11 45 66

Grifo mural fregadera caño tubo alto 24cm
Wall sink tap with 24 cm tube spout



Ref.: 68003 11 45 66

Grifo fregadera caño tubo vertical
Sink tap with vertical swan neck spout



Ref.: 68083 11 45 66

Grifo fregadera mural caño tubo vertical
Wall sink tap with swan neck spout

Gamma Cocina | Kitchen



Ref.: 68194 11 45 66
Mezclador mesada 6" caño tubo
Top mixer with 6" swan neck spout



Ref.: 68199 11 45 66
Mezclador mesada 8" caño tubo
Top mixer with 8" swan neck spout

Gamma Cocina | Kitchen



Ref.: 568195 45
Cuerpo grupo mural 11 cm
Wall-mounted mixer 11 cm



Ref.: 568193 45
Cuerpo grupo mural 15cm
Wall-mounted mixer 15 cm

Gamma Cocina | *Kitchen*



Ref.: 568104 45
Cuerpo grupo mural 20cm
Wall-mounted mixer 20 cm



Ref.: 568083 45
Cuerpo grifo mural
Wall tap

Gamma Cocina | *Kitchen*



Ref.: 68901 45
Caño alto tubo 18 cm
High tube spout 18 cm

Ref.: 68902 45
Caño alto tubo 24 cm
High tube spout 24 cm

Ref.: 68908 45
Caño alto tubo 30 cm
High tube spout 30 cm



Ref.: 68910 45
Caño bajo tubo 18 cm
Low tube spout 18 cm

Ref.: 68904 45
Caño bajo tubo 24 cm
Low tube spout 24 cm

Ref.: 68909 45
Caño bajo tubo 30 cm
Low tube spout 30 cm



Ref.: 68903 45
Caño tubo vertical
Swan neck spout

Kalo

Acabado cromado. Montura 1/4 vuelta cierre cerámico | *Ceramic headwork quarter turn*

DISEÑO MODULAR PARA TODOS LOS ESTILOS

Genebre ha diseñado tres series de grifería bimando que combinan de forma perfecta y armoniosa los diferentes caños y volantes: Kalo, Kross e Ixo. Una propuesta muy versátil de formas sencillas y elegantes que permite múltiples combinaciones, únicas y personales.

MODULAR DESIGN FOR ALL STYLES

Genebre has designed three series of dual-handle taps that perfectly and harmoniously combine these different spouts and handles: Kalo, Kross and Ixo. A versatile design with simple elegant forms which allow for multiple, personal and unique combinations.



Kalo Bateria de lavabo | *Widespread wash-basin mixers*



Ref.: 68120 07 45 66
Bateria de lavabo caño recto
Widespread wash-basin mixer with straight pipe



Ref.: 68124 07 45 66
Bateria de lavabo caño cisne
Widespread wash-basin mixer with swan neck pipe



Ref.: 68125 07 45 66
Bateria de lavabo caño inclinado
Widespread wash-basin mixer with sloping pipe

Kalo Lavabo empotrado | *Built-in wash-basin mixers*



Ref.: 68131 07 45 66
Grupo de lavabo empotrado caño 16 cm
Built-in wash-basin mixer with 16 cm pipe



Ref.: 68132 07 45 66
Grupo de lavabo empotrado caño 22 cm
Built-in wash-basin mixer with 22 cm pipe

Kalo Inversor | *Diverter*



Ref.: 63114 30 45 66

Inversor cerámico 3 vías empotrado placa redonda
Built-in 3-way ceramic diverter round plate

Kalo Baño y ducha empotrado | *Built-in bath & shower mixers*

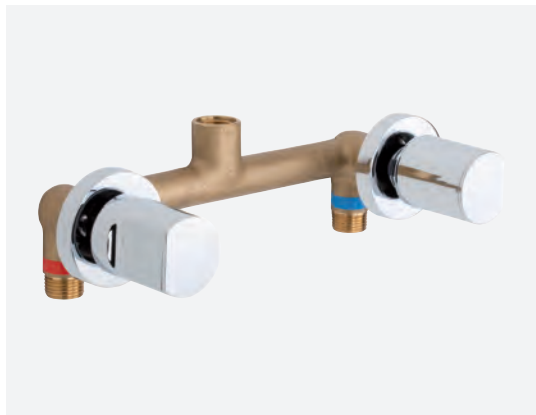

Ref.: 68115 07 45 66

Grupo ducha empotrado 8"
Built-in 8" shower mixer



Ref.: 68116 07 45 66

Grupo ducha empotrado 8" con inversor
Built-in 8" shower mixer with diverter

Kalo Bateria de bidé | *Widespread bidet mixer*



Ref.: 68142 07 45 66

Bateria de bidé con transmisión
Widespread bidet mixer with transmission

Kalo Llave de paso | *Stopcock*



Ref.: 68170 07 45 66

Llave de paso 1/2"
Stopcock 1/2"

Kross

Acabado cromado. Montura 1/4 vuelta cierre cerámico | *Chromed finish. Ceramic headwork quarter turn*

EN LA VARIEDAD ESTÁ EL GUSTO

Los volantes de la serie Kross están diseñados para ser los protagonistas de los baños más elegantes. Y la posibilidad de combinarse con diferentes tipos de caños le permite múltiples opciones para adaptarse a cada estilo de baño.

A TASTE FOR DIVERSITY

The handle in the Kross series are designed to be the main focus of the most elegant bathrooms. They offer the possibility to combine with different types of spouts that allow for multiple options to adapt to each style of bathroom.



Kross Bateria de lavabo | *Widespread wash-basin mixers*



Ref.: 68120 08 45 66
Bateria de lavabo caño recto
Widespread wash-basin mixer with straight pipe



Ref.: 68124 08 45 66
Bateria de lavabo caño cisne
Widespread wash-basin mixer with swan neck pipe



Ref.: 68125 08 45 66
Bateria de lavabo caño inclinado
Widespread wash-basin mixer with sloping pipe

Kross Lavabo empotrado | *Built-in wash-basin mixers*



Ref.: 68131 08 45 66
Grupo de lavabo empotrado caño 16 cm
Built-in wash-basin with 16 cm pipe



Ref.: 68132 08 45 66
Grupo de lavabo empotrado caño 22 cm
Built-in wash-basin with 22 cm pipe

Kross Inversor | *Diverter*



Ref.: 63114 30 45 66
 Inversor cerámico 3 vías empotrado
Built-in 3 way ceramic diverter

Kross Baño y Ducha empotrado | *Built-in bath & shower mixers*

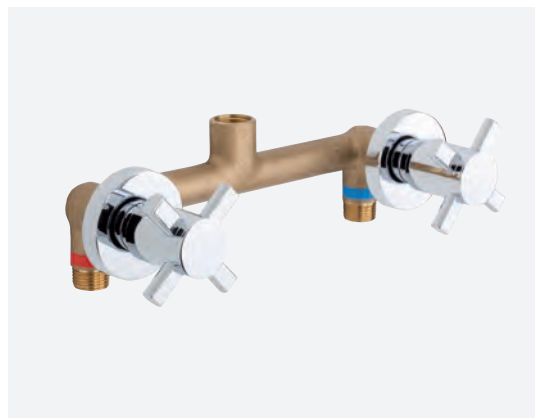

Ref.: 68115 08 45 66
 Grupo ducha empotrado 8"
Built-in 8" shower mixer

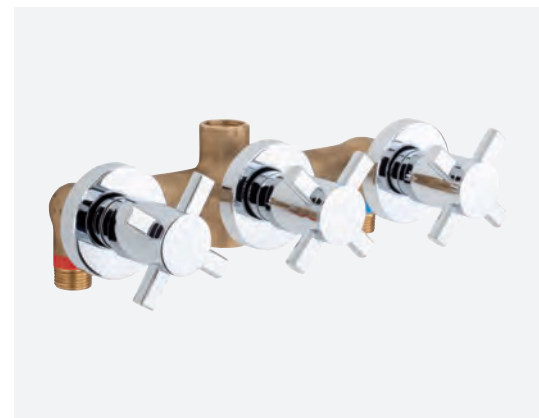

Ref.: 68116 08 45 66
 Grupo ducha empotrado 8" con inversor
Built-in 8" shower mixer with diverter

Kross Bateria de bidé | *Widespread bidet mixer*



Ref.: 68142 08 45 66
 Bateria de bidé con transmisión
Widespread bidet mixer with transmission

Kross Llave de paso | *Stopcock*



Ref.: 68170 08 45 66
 Llave de paso 1/2"
Stopcock 1/2"



Acabado cromado. Montura 1/4 vuelta cierre cerámico | *Chromed finish. Ceramic headwork quarter turn*

INFINITAS POSIBILIDADES

Fusión entre elegancia clásica y minimalismo. Los volantes del modelo Ixo de formas geométricas y muy estilizadas son ideales para conjuntar con las múltiples posibilidades de caños que ofrece la colección. Un diseño actual y hermoso que consigue un ambiente muy especial.

INFINITE POSSIBILITIES

A fusion of classic elegance and minimalism. The handles of the Ixo model with geometric stylised forms are ideal to match with the multiple possibilities of spouts that the collection offers. A current, attractive design that achieves a very special ambience.



Ixo Bateria de lavabo | *Widespread wash-basin mixers*



Ref.: 68120 12 45 66
Bateria de lavabo caño recto
Widespread wash-basin mixer with straight pipe



Ref.: 68124 12 45 66
Bateria de lavabo caño cisne
Widespread wash-basin mixer with swan neck pipe



Ref.: 68125 12 45 66
Bateria de lavabo caño inclinado
Widespread wash-basin mixer with sloping pipe

Ixo Lavabo empotrado | *Built-in wash-basin mixers*



Ref.: 68131 12 45 66
Grupo de lavabo empotrado caño 16 cm
Built-in wash basin with 16 cm pipe



Ref.: 68132 12 45 66
Grupo de lavabo empotrado caño 22 cm
Built-in wash basin with 22 cm pipe

Ixo Inversor | *Diverter*



Ref.: 63114 30 45 66
 Inversor cerámico 3 vías empotrado placa redonda
Built-in 3-way ceramic diverter round plate

Ixo Baño y Ducha empotrado | *Built-in bath & shower mixers*

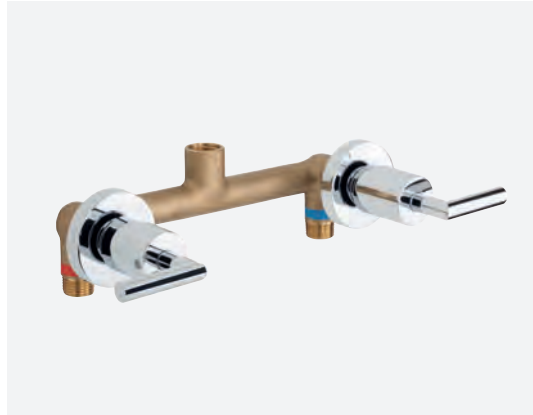

Ref.: 68115 12 45 66
 Grupo ducha empotrado 8"
Built-in 8" shower mixer



Ref.: 68116 12 45 66
 Grupo ducha empotrado 8" con inversor
Built-in 8" shower mixer with diverter

Ixo Bateria de bidé | *Widespread bidet mixer*



Ref.: 68142 12 45 66
 Bateria de bidé con transmisión
Widespread bidet mixer with transmission

Ixo Llave de paso | *Stopcock*



Ref.: 68170 12 45 66
 Llave de paso 1/2"
Stopcock 1/2"

Style Shower

DUCHAS CON ESTILO

Para que a la ducha no le falte de nada. Disponemos de una amplia gama de mangos de duchas, accesorios y complementos ideales para cada modelo. Una colección que convierte a cada pieza en una creación inteligente y totalmente flexible para un entorno de bienestar.

SHOWERS WITH STYLE

For the shower that has everything. We have a wide range of jet handshowers, accessories and complements ideal for each model. A collection that turns each piece in to an intelligent creation, totally flexible for an environment of well being.



Style Shower



Ref.: 65114 30 45 66
Inversor cerámico 3 vías empotrado placa cuadrada
Built-in 3-way ceramic diverter with square plate

Ref.: 65115 18 45 66
Monomando de ducha empotrado
Built-in single lever shower

Ref.: 1643 45
Rociador doble función cascada-lluvia
Shower head double function waterfall-rain

Ref.: 1680 04
Toma ducha mural redonda
Round flexible wall connector

Ref.: 1748 45
Conjunto Tau, barra, flexo y ducha 5 jets (caja)
Tau set, bar, hose and 5 jets handshower (box)



Ref.: 63116 26 45 66
Monomando de baño empotrado con inversor
Built-in single lever bath mixer with diverter

Ref.: 1672 45
Brazo a techo cuadrado 15 cm
Square roof arm 15 cm

Ref.: R63112 26
Rociador cuadrado 22 cm
Square shower head 22 cm

Ref.: 1679 04
Toma ducha mural cuadrada
Square flexible wall connector

Ref.: 1747 45
Conjunto Kenjo, barra, flexo y ducha 3 jets (caja)
Kenjo set, bar, flexible hose and 3 jets handshower (box)



Ref.: 65118 18 45 66
Monomando empotrado con inversor cerámico 3 vías
Built-in single handle mixer with 3-way ceramic diverter

Ref.: B65113 18
Brazo pared redondo 35 cm
Round arm 35 cm

Ref.: R65112 18
Rociador redondo 22 cm
Round shower head Ø 22 cm

Ref.: 1680 04
Toma ducha mural redonda
Round flexible wall connector

Ref.: 1748 45
Conjunto Tau, barra, flexo y ducha 5 jets (caja)
Tau set, bar, hose and 5 jets handshower (box)

Ref.: 1668 45
Caño mural baño cilíndrico
Round wall bath spout

Style Shower



Ref.: 64118 04 45 66
 Monomando empotrado con inversor cerámico 3 vías
Built-in single handle mixer with 3-way ceramic diverter
Ref.: 1671 45
 Brazo a techo redondo 15 cm
Round roof arm 15 cm
Ref.: R65112 18
 Rociador redondo 22 cm
Round shower head Ø 22 cm
Ref.: 1680 04
 Toma ducha mural redonda
Round flexible wall connector
Ref.: 1639 45
 Barra ducha metálica (caja)
Metalic shower bar (box)
Ref.: 100140 30
 Flexo 1,70 m. PVC antirrotura y tuerca loca
PVC flexible hose 1.70 m anti-breaking and swiveling nut
Ref.: DXT3 45
 Mango de ducha T3 jets (caja)
T3 jets handshower (box)
Ref.: 1668 45
 Caño mural baño cilíndrico
Round wall bath spout



Ref.: 63100 26 45 67
 Monomando de baño
Single lever bath mixer
Ref.: 1746 45
 Set columna extensible con ducha, soporte y flexo
Extendible column set with shower, holder and flexible hose



Ref.: 67110 26 45 67
 Termostática ducha sin kit
Thermostatic shower without kit
Ref.: 1746 45
 Set columna extensible con ducha, soporte y flexo
Extendible column set with shower, holder and flexible hose

Style Shower



Ref.: 64115 16 45 66

Monomando de ducha empotrado

Built-in single lever shower

Ref.: 1680 04

Toma ducha mural redonda

Round flexible wall connector

Ref.: 1745 45

Set columna extensible con ducha, soporte y flexo

Extensible column set with shower, holder and flexible hose



Ref.: 68115 08 45 66

Ducha empotrada

Built-in shower

Ref.: 1680 04

Toma ducha mural redonda

Round flexible wall connector

Ref.: 1745 45

Set columna extensible con ducha, soporte y flexo

Extensible column set with shower, holder and flexible hose



Ref.: 68116 12 45 66

Baño / ducha empotrado

Built-in bath-shower

Ref.: 63114 30 45 66

Inversor cerámico 3 vías empotrado placa redonda

Built-in 3-way ceramic diverter with round plate

Ref.: 1643 45

Rociador doble función cascada-lluvia

Shower head double function waterfall-rain

Ref.: 1633 04

Soporte ducha con toma cilíndrico

Round shower holder with flexible connector

Ref.: 100137 60 00

Flexo extensible 1,70 - 2,25 m inoxidable doble grapaje

Extensible double lock stainless steel flexible hose 1.70 to 2.25 m

Ref.: DXT3 45

Mango de ducha T3 jets (caja)

T3 jets handshower (box)

Ref.: 1668 45

Caño mural baño cilíndrico

Round wall bath spout

Style Shower



Ref.: 62117 31 45 66

Monomando empotrado con inversor cerámico 2 vías

Built-in single handle mixer with 2-way ceramic diverter

Ref.: 1671 45

Brazo a techo redondo 15 cm

Round roof arm 15 cm

Ref.: R63112 08

Rociador ovalado 22 cm

Oval shower head 22 cm

Ref.: 1633 04

Soporte ducha con toma cilíndrico

Round shower holder with flexible connector

Ref.: 100137 60 00

Flexo extensible 1,70 - 2,25 m inoxidable doble grapaje

Extensible double lock stainless steel flexible hose 1.70 to 2.25 m

Ref.: DX03 45

Mango de ducha T3 jets (caja)

T3 jets handshower (box)



Ref.: 64116 14 45 66

Monomando de baño empotrado con inversor

Built-in single lever bath with diverter

Ref.: B65113 18

Brazo pared redondo 35 cm

Round arm 35 cm

Ref.: R65112 18

Rociador redondo 22 cm

Round shower head Ø 22 cm

Ref.: 1668 45

Caño mural baño cilíndrico

Round wall bath spout



Ref.: 63116 26 45 66

Monomando de baño empotrado con inversor

Built-in single lever bath with diverter

Ref.: B63113 26

Brazo pared cuadrado 35 cm

Square wall arm 35 cm

Ref.: R63112 26

Rociador cuadrado 22 cm

Square shower head 22 cm

Ref.: 1674 45

Caño mural baño cuadrado

Square wall bath spout

Accesorios

Accessories

HASTA EL ÚLTIMO DETALLE

Genebre te ofrece una larga lista de accesorios y complementos funcionales y decorativos ideales para combinar con nuestros modelos de grifería y dar un toque personal a cada baño.

DOWN TO THE LAST DETAIL

Genebre offers a long list of accessories and functional and decorative complements, ideal to combine with our models of taps, and give a personal touch to each bathroom.



Accesorios Mangos de ducha | Accessories Handshowers



Ref.: DXK3 45
Mango de ducha K3 jets (caja)
K3 jets handshower (box)



Ref.: DXT5 45
Mango de ducha T5 jets (caja)
T5 jets handshower (box)



Ref.: DXT3 45
Mango de ducha T3 jets (caja)
T3 jets handshower (box)

Accesorios Mangos de ducha | Accessories Handshowers



Ref.: DX03 45
Mango de ducha O3 jets (caja)
O3 jets handshower (box)



Ref.: DXE5 45
Mango de ducha E5 jets (caja)
E5 jets handshower (box)



Ref.: DXE2 45
Mango de ducha E2 jets (caja)
E2 jets handshower (box)

Accesorios Mangos de ducha | Accessories Handshowers



Ref.: DXK1 45
Mango de ducha K1 jets (caja)
K1 jet handshower (box)



Ref.: 100197 45 00
Mango de ducha C1 jet (bolsa)
C1 jet handshower (bag)



Ref.: 100175 45 00
Mango de ducha E1 jet (bolsa)
E1 jet handshower (bag)

Accesorios Kits de ducha | Accessories Shower kits



Ref.: 100698 45
Kit de ducha Kenjo, flexo, soporte y ducha 3 jets (caja)
Kenjo shower set, flexible hose, holder and 3 jets handshower (box)



Ref.: 100699 45
Kit de ducha Tau, flexo, soporte y ducha 5 jets (caja)
Tau shower set, flexible hose, holder and 5 jets handshower (box)

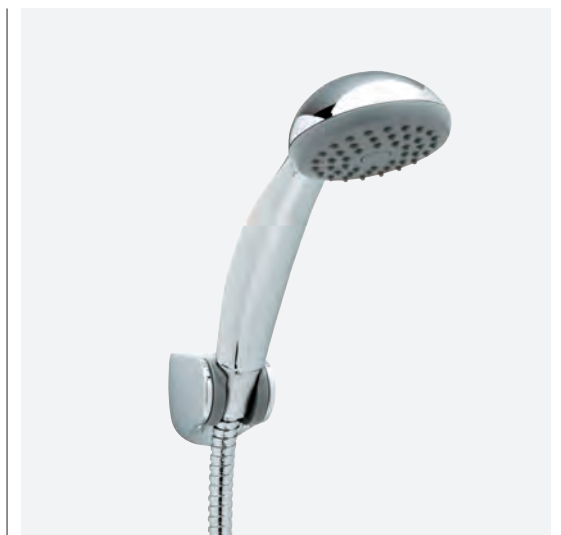

Ref.: 100697 45
Kit de ducha GE2, flexo, soporte y ducha 1 jet (caja)
GE2 shower set, flexible hose, holder and 1 jet handshower (box)

Accesorios Conjuntos barra | Accessories Bar sets



Ref.: 1748 45
Conjunto Tau, barra, flexo y ducha 5 jets (caja)
Tau set, bar, hose and 5 jets handshower (box)



Ref.: 1747 45
Conjunto Kenjo, barra, flexo y ducha 3 jets (caja)
Kenjo set, bar, flexible hose and 3 jets handshower (box)

Barra ducha | Shower bars



Ref.: 1637 45
Barra ducha Kenjo (caja)
Kenjo shower bar (box)

Accesorios Barra ducha | Accessories Shower bars



Ref.: 1636 45
Barra ducha TAU (caja)
TAU shower bar (box)



Ref.: 1638 45
Barra ducha redonda (caja)
Round shower bar (box)



Ref.: 1639 45
Barra ducha metálica (caja)
Metallic shower bar (box)

Accesorios Flexos | Accessories Flexible hoses



Ref.: 100135 60 00
Flexo 1,70 m inoxidable
Stainless steel flexible hose 1.70 m



Ref.: 100137 60 00
Flexo extensible 1,70 - 2,25 m inoxidable doble
grapaje
*Extensible double lock stainless steel flexible hose
1.70 to 2.25 m*

Accesorios Flexos | Accessories Flexible hoses



Ref.: 100140 30
Flexo 1,70 m. PVC antirrotura y tuerca loca
*PVC flexible hose 1.70 m anti-breaking and
swiveling nut*



Ref.: 100141 45
Flexo 1,20 m inoxidable
Stainless steel flexible hose 1.20 m

Accesorios Soportes ducha | Accessories Shower holders



Ref.: 100152 45
Soporte ducha Combi
Combi shower holder



Ref.: 100149 45
Soporte ducha Kenjo
Kenjo shower holder



Ref.: 100153 45
Soporte ducha cilíndrico
Cylindrical shower holder

Accesorios Soportes ducha | Accessories Shower holders



Ref.: 100068 45
Soporte ducha ovalado
Oval shower holder



Ref.: 1633 04
Soporte ducha con toma cilíndrico
Round shower holder with flexible connector



Ref.: 1649 04
Soporte ducha con toma cuadrado
Square shower holder with flexible connector

Accesorios Tomas de ducha | Accessories Wall connectors



Ref.: 1680 04
Toma ducha mural redonda
Round flexible wall connector



Ref.: 1679 04
Toma ducha mural cuadrada
Square flexible wall connector

Accesorios Rociadores y brazos | Accessories Shower heads and sprayer arms



Ref.: 1643 45
Rociador doble función cascada-lluvia
Shower head double function waterfall-rain



Ref.: R63112 08
Rociador ovalado 22 cm
Oval shower head 22 cm
Ref.: 1671 45
Brazo a techo redondo 15 cm
Round roof arm 15 cm



Ref.: R63112 26
Rociador cuadrado 22 cm
Square shower head 22 cm
Ref.: 1672 45
Brazo a techo cuadrado 15 cm
Square roof arm 15 cm

Accesorios Rociadores y brazos | Accessories Shower heads and sprayer arms



Ref.: R65112 18

Rociador redondo 22 cm

Round shower head Ø 22 cm

Ref.: 1671 45

Brazo a techo redondo 15 cm

Round roof arm 15 cm



Ref.: R65112 08

Rociador ovalado 22 cm

Oval shower head Ø 22 cm

Ref.: B65113 18

Brazo pared redondo 35 cm

Round arm 35 cm



Ref.: R63112 26

Rociador cuadrado 22cm

Sqaure shower head 22cm

Ref.: B63113 26

Brazo pared cuadrado 35 cm

Square wall arm 35 cm

Accesorios Rociadores y brazos | Accessories Shower heads and sprayer arms



Ref.: R65112 18

Rociador redondo 22 cm

Round shower head Ø 22 cm

Ref.: B65113 18

Brazo pared redondo 35 cm

Round arm 35 cm



Ref.: 1698 45

Rociador ducha con brazo

Wall shower arm and spray

Accesorios Válvulas de escuadra | Accessories Angle valves



Ref.: 3104 04
Válvula de escuadra redonda 3/8"
Round angle valve 3/8"

Ref.: 3104 05
Válvula de escuadra redonda 1/2"
Round angle valve 1/2"



Ref.: 3106 04
Válvula de escuadra cuadrada 3/8"
Square angle valve 3/8"

Ref.: 3106 05
Válvula de escuadra cuadrada 1/2"
Square angle valve 1/2"

Accesorios Válvulas de escuadra | Accessories Angle valves



Ref.: 3107 03
Válvula de escuadra doble 1/2" - 3/8" ducha-inodoro
Double angle valve 1/2" - 3/8" shower-toilet

Ref.: 3107 04
Válvula de escuadra doble 1/2" - 1/2" ducha-inodoro
Double angle valve 1/2" - 1/2" shower-toilet



Ref.: 3108 03
Válvula de escuadra doble 1/2" - 3/8" ducha-inodoro
Inox
Inox double angle valve 1/2" - 3/8" shower-toilet

Ref.: 3108 04
Válvula de escuadra doble 1/2" - 1/2" ducha-inodoro
Inox
Inox double angle valve 1/2" - 1/2" shower-toilet

Accesorios Kits de ducha | Accessories Shower kits



Ref.: 100694 45
Kit ducha sanitaria
Sanitary shower kit



Ref.: 100694 60
Kit ducha sanitaria. Inox
Inox sanitary shower kit



Ref.: 100696 45
Kit soporte y ducha sanitaria
Sanitary shower and holder kit

Accesorios Caños baño | Accessories Bath spouts



Ref.: 1667 45
Caño mural baño fundido
Casted wall bath spout



Ref.: 1668 45
Caño mural baño cilíndrico
Round wall bath spout



Ref.: 1674 45
Caño mural baño cuadrado
Square wall bath spout

Accesorios Caños lavabo | Accessories Wash basin spout



Ref.: 68911 45
Caño mural tubo recto 16 cm
Wall-mounted pipe spout 16 cm



Ref.: 68912 45
Caño mural tubo recto 22 cm
Wall-mounted pipe spout 22 cm



Ref.: 68913 45
Caño mural tubo inclinado 20 cm
Wall-mounted with sloping pipe, 20 cm spout

Accesorios Caños lavabo | Accessories Wash basin spout



Ref.: 68914 45
Caño mural tubo retro 20 cm
Wall-mounted with retro pipe, 20 cm spout

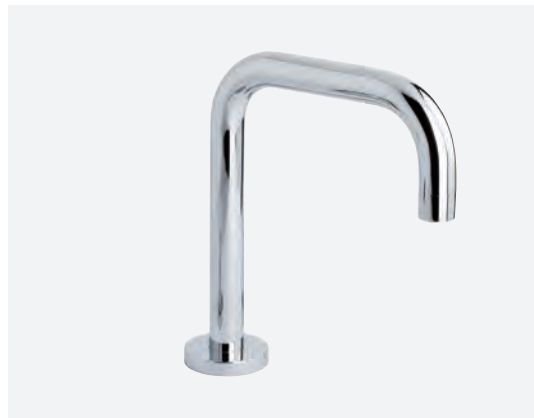

Ref.: 68915 45
Caño encimera recto tubo
Straight pipe spout



Ref.: 68916 45
Caño encimera cisne tubo
Swan neck pipe spout

Accesorios Sifones | Accessories Siphons



Ref.: 68917 45
Caño encimera inclinado tubo
Sloping pipe spout

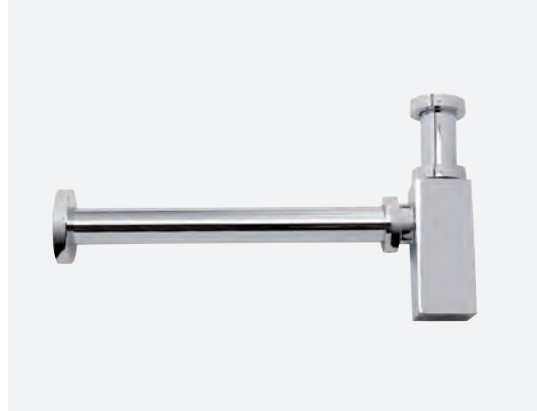

Ref.: 1621 07
Sifon botella para lavabo y bidé 1 1/4"
1 1/4" bidet and wash-basin siphon



Ref.: 1622 07
Sifon botella para lavabo y bidé 1 1/4"
1 1/4" bidet and wash-basin siphon

Accesorios Sifones | Accessories Siphons



Ref.: 100134 07
Tuerca para sifón 1 1/4"
1 1/4" siphon nut



Ref.: 100134 08
Tuerca para sifón 1 1/2"
1 1/2" siphon nut



Ref.: 9908 0046
Adaptador sifon 1 1/4" - 1"
Siphon adaptor 1 1/4" - 1"

Accesorios Válvulas de desagüe | Accessories Drain valves



Ref.: 100202 45
Tapa universal "Click remove"
"Click remove" universal cover



Ref.: 100211 45
Válvula click "Luxe" 1 1/4"
1 1/4" "Luxe" click valve



Ref.: 100211 43
Válvula click "Luxe" bronce 1 1/4"
1 1/4" "Luxe" bronze click valve

Accesorios Válvulas de desagüe | Accessories Drain valves



Ref.: 100205 45
Válvula click universal 1 1/4"
1 1/4" universal click valve



Ref.: 100204 45
Válvula click Kenjo 1 1/4"
1 1/4" Kenjo click valve



Ref.: 100206 45
Válvula click 1 1/4" con rebosadero
1 1/4" click valve with overflow

Accesorios Válvulas de desagüe | Accessories Drain valves



Ref.: 100207 45
Válvula click 1 1/4"
1 1/4" click valve



Ref.: 100208 45
Válvula click 1 1/4" bañera
1 1/4" bath click valve



Ref.: 100209 45
Válvula click 1 1/4" con/sin rebosadero
1 1/4" click valve with/out overflow

Accesorios Válvulas de desagüe | Accessories Drain valves



Ref.: 100210 45
Válvula click 1 1/4" con/sin rebosadero
1 1/4" click valve with/out overflow



Ref.: 100200 45
Válvula automática plástico 1 1/4"
1 1/4" plastic automatic valve



Ref.: 100203 45
Válvula automática metálica 1 1/4"
1 1/4" metallic automatic valve

Accesorios | Accessories



Ref.: 100122 45
Conjunto florón y excéntricas gigantes
Giant escutcheon eccentric set



Ref.: P130
Placa adaptadora 4"
4" adaptor plate



Ref.: P200
Placa adaptadora 8"
8" adaptor plate

Recambios *Spare parts*

LA IMPORTANCIA DE LAS PIEZAS

Es importante disponer de las piezas de recambio para mantener el baño siempre en perfecto estado aunque pase el tiempo. Por eso, contamos con una gran colección de piezas exclusivas con la misma calidad de siempre.

THE IMPORTANCE OF THE PARTS

It is important to have the spare parts available to always keep the bathroom in a perfect state through the pass of time. Therefore, we have a large collection of exclusive pieces with the same quality as always.



38°



Recambios Spare parts



Maneta | Handle

Ref.:

100001F 04 45
100001V 04 45
100001 06 45
100001V 06 45
100001 08 45
100001 14 45
100001V 14 45
100001 16 45
100001V 16 45
100001 18 45
100001V 18 45
100001 19 45
100001V 19 45
100001 22 45
100001V 22 45
100001 26 45
100001V 26 45
100001 29 45
100001V 29 45
100001 31 45
100001 33 45
100001 36 45
100001V 39 45
100001V 37 45
9908 0039
9908 0040
9908 0041
9908 0045

Descripción | Description

Maneta Kelogic marcado apertura en frío | *Cold opening Kelogic handle*
Maneta Kelogic marcado vertical | *Vertical marked Kelogic handle*
Maneta Sigma | *Sigma handle*
Maneta Sigma marcado vertical | *Vertical marked Sigma handle*
Maneta Kode | *Kode handle*
Maneta Klip2 | *Klip2 handle*
Maneta Klip2 marcado vertical | *Vertical marked Klip2 handle*
Maneta Klip | *Klip handle*
Maneta Klip marcado vertical | *Vertical marked Klip handle*
Maneta Tau | *Tau handle*
Maneta Tau marcado vertical | *Vertical marked Tau handle*
Maneta Oslo | *Oslo handle*
Maneta Oslo marcado vertical | *Vertical marked Oslo handle*
Maneta GE2 | *GE2 handle*
Maneta GE2 marcado vertical | *Vertical marked GE2 handle*
Maneta Kenjo | *Kenjo handle*
Maneta Kenjo marcado vertical | *Vertical marked Kenjo handle*
Maneta Tau2 | *Tau2 handle*
Maneta Tau2 marcado vertical | *Vertical marked Tau2 handle*
Maneta Kode corta | *Short Kode handle*
Maneta GE2 corta | *Short GE2 handle*
Maneta Kode larga | *Long Kode handle*
Maneta New Regent marcado vertical | *Vertical marked New Regent handle*
Maneta Tau 35 marcado vertical | *Vertical marked Tau 35 handle*
Maneta FRT65401 | *FRT65401 handle*
Maneta FRT65402 | *FRT65402 handle*
Maneta FRV61205 | *FRV61205 handle*
Maneta FRK63400 | *FRK63400 handle*

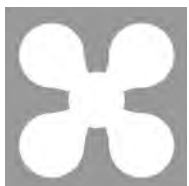

Volantes | Handles

68998 07 45
68998 08 45
68998 09 45
68998 09 43
68998 11 45
68998 12 45
68998 28 45
68998 30 45

Volante Kalo | *Kalo handle*
Volante Kross | *Kross handle*
Volante Regent | *Regent handle*
Volante Regent Bronce | *Bronze Regent handle*
Volante Gamma | *Gamma handle*
Volante Ixo | *Ixo handle*
Volante Office | *Office handle*
Volante Tau | *Tau handle*

Recambios Spare parts

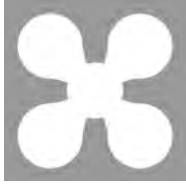

Volantes | Handles



Duchas | Shower



Flexo | Flexible hose

Ref.:

68998 31 45
68988 18
68989 26
68991 14
68992 26
68994 14
68998 10
68998 14

DXK3 45
DXO3 45
DXT3 45
DXT5 45
100175 45 00
100187 45
100190 45
100196 43 00
100196 45 00
100197 45 00
100198 45
100199 45
100252 45
100696 45
R62112 08
R63112 26
R65112 18

100135 43 00
100135 60 00
100136
100140 30
100141 45
100143 45

Descripción | Description

Volante osmosis | *Osmosis handle*
Kit volantes columnas termostáticas Tau | *Tau thermostatic column handle set*
Kit volantes columnas termostáticas Kenjo | *Kenjo thermostatic column handle set*
Kit volantes termostáticas Lunic | *Lunic thermostatic handle set*
Kit volantes termostáticas Kenjo | *Kenjo thermostatic handle set*
Kit volantes termostáticas GE-Class | *GE-Class thermostatic handle set*
Kit volante termostática empotrada 1 salida | *Built-in thermostatic handle set*
Kit volante termostática empotrada | *Built-in thermostatic handle set*

Mango de ducha K3 jets (caja) | *K3 jets handshower (box)*
Mango de ducha O3 jets (caja) | *O3 jets handshower (box)*
Mango de ducha T3 jets (caja) | *T3 jets handshower (box)*
Mango de ducha T5 jets (caja) | *T5 jets handshower (box)*
Mango de ducha E1 jet (bolsa) | *GE2 1 jet hand shower (bag)*
Mango ducha extraíble para 65206 | *Pull-out 65206 sink tap sprayer*
Mango ducha de fregadera extraíble | *Pull-out sink tap sprayer*
Mango de ducha New Regent bronce | *New Regent bronze hand shower*
Mango de ducha New Regent cromo | *New Regent chromed hand shower*
Mango de ducha C1 jet (bolsa) | *Klip 1 jet hand shower (bag)*
Mango ducha extraíble para FRV61206 | *Pull-out FRV61206 sink tap sprayer*
Mango ducha extraíble para FRV61205 | *Pull-out FRV61205 sink tap sprayer*
Mango extraíble fregadera | *Pull-out sink tap sprayer*
Kit soporte y teleducha cromo | *Holder and shower set*
Rociador D22 Ovalado | *Oval D22 shower sprayer*
Rociador D22 Kenjo | *Kenjo D22 shower sprayer*
Rociador D22 Tau | *Tau D22 shower sprayer*

Flexo H 1/2" - H 1/2" bronce 170 cm F 1/2" | *F 1/2" bronze 170 cm flexible hose*
Flexo H 1/2" - H 1/2" 170 cm F 1/2" - F 1/2" 170 cm flexible hose
Flexo nylon para FRV61206 | *Nylon flexible hose for FRV61206 sink tap*
Flexo PVC H 1/2" - H 1/2" plata 170 cm | *F 1/2" - F 1/2" 170 cm PVC silver flexible hose*
Flexo teleducha H 1/2" - H 1/2" 120 cm | *F 1/2" - F 1/2" 120 cm Bidet shower flexible hose*
Flexo fregadera 15x1 - H 1/2" 115 cm 15x1 | *F 1/2" 115 cm pull-out sink tap hose*

Recambios Spare parts



Soporte | Holder



Caño | Spout



Atomizador | Aerator

Ref.:

100068 45
100149 45
100152 45
100153 45
1649 45
1649 43
9908 0031
9908 0034

68901 45
68902 45
68903 45
68904 45
68908 45
68909 45
68910 45
68911 45
68912 45
68913 45
68914 45
68915 45
68916 45
68917 45
68924 45
68925 45
68926 45
68927 45
68928 45
68929 45

100066 45
100069 43
100069 45
100072 45
100074 45
100077 45

Descripción | Description

Soporte ducha ovalado | *Oval shower holder*
Soporte ducha Kenjo | *Kenjo shower holder*
Soporte ducha Combi | *Combi shower holder*
Soporte ducha Tau / Klip | *Tau shower holder*
Soporte ducha Clásico | *Classic shower holder*
Soporte ducha Clásico bronce | *Classic bronze shower holder*
Soporte deslizante columna redonda | *Round column shower holder*
Soporte deslizante columna cuadrada | *Square column shower holder*

Caño alto tubo 18 cm | *High pipe spout 18 cm*
Caño alto tubo 24 cm | *High pipe spout 24 cm*
Caño tubo vertical | *Vertical pipe spout*
Caño bajo tubo 24 cm | *Low pipe spout 24 cm*
Caño alto tubo 30 cm | *High pipe spout 30 cm*
Caño bajo tubo 30 cm | *Low pipe spout 30 cm*
Caño bajo tubo 18 cm | *Low pipe spout 18 cm*
Caño mural tubo recto 16 cm | *Wall mounted pipe spout 16 cm*
Caño mural tubo recto 22 cm | *Wall mounted pipe spout 22 cm*
Caño mural tubo inclinado 20 cm | *Wall mounted sloping pipe spout 20 cm*
Caño mural tubo retro 20 cm | *Wall mounted retro pipe spout 20 cm*
Caño encimera recto tubo | *Straight pipe spout*
Caño encimera cisne tubo | *Swan neck pipe spout*
Caño encimera inclinado tubo | *Sloping pipe spout*
Caño mural tubo recto 16 cm | *Wall mounted pipe spout 16 cm*
Caño mural tubo recto 22 cm | *Wall mounted pipe spout 22 cm*
Caño mural rectangular 16 cm | *Wall mounted rectangular pipe spout 16 cm*
Caño mural rectangular 22 cm | *Wall mounted rectangular pipe spout 22 cm*
Caño mural tubo recto 16 cm | *Wall mounted pipe spout 16 cm*
Caño mural tubo recto 22 cm | *Wall mounted pipe spout 22 cm*

Atomizador M18x1 antical | *M18x1 anti-lime aerator*
Atomizador H22x1 antical bronce retro | *F22x1 bronze anti-lime retro aerator*
Atomizador H22x1 antical retro | *F22x1 anti-lime retro aerator*
Atomizador M24x1 antical antivandálico | *M24x1 Antivandal anti-lime aerator*
Atomizador M24x1 antical economizador Kelogic | *M24x1 Antivandal anti-lime Kelogic aerator*
Atomizador M24x1 antical economizador (blister 2 u.) | *M24x1 Economizer anti-lime aerator (blister 2 u.)*

Recambios Spare parts



Atomizador | Aerator



Cartucho | Cartridge



Montura
Headwork

Ref.:

100078 45

100080 45

100082 45

100083 43

100083 45

100085 43

100085 45

100086 43

100086 45

100088 45

100089 45

9908 0043

9908 0044

9908 0026

100037

100038

100042

100044

100045

100046

100048

100049

100051

100053

100054

100056

100064

67895 45

67896 45

67897 45

67898 45

67993 14

Descripción | Description

Atomizador H22x1 antical economizador(blisters 2 u.) | *F22x1 Economizer anti-lime aerator (blister 2 u.)*

Atomizador para 65203 | *65203 aerator*

Atomizador 2 salidas antical Osmosis | *Double flow osmotic anti-lime aerator*

Atomizador M28x1 antical bronce | *M28x1 anti-lime bronze aerator*

Atomizador M28x1 antical | *M28x1 anti-lime aerator*

Atomizador M24x1 antical bronce | *M24x1 anti-lime bronze aerator*

Atomizador M24x1 antical | *M24x1 anti-lime aerator*

Atomizador M24x1 antical con rótula bronce | *M24x1 bronze anti-lime aerator w/kneecap*

Atomizador M24x1 antical con rótula | *M24x1 anti-lime aerator w/kneecap*

Atomizador H22x1 antical | *F22x1 anti-lime aerator*

Atomizador H18x1 antical | *F18x1 aerator anti-lime*

Atomizador para 65203 Inox | *Inox 65203 aerator*

Atomizador para 65208 inox | *Inox 65208 aerator*

Atomizador para caño rectangular | *Rectangular spout aerator*

Cartucho termóstática | *Thermostatic cartridge*

Cartucho termostático empotrar Lunic | *Lunic built-in tap thermostatic cartridge*

Cartucho cerámico D25 convencional 1 agua | *1 water conventional D25 ceramic cartridge*

Cartucho cerámico D25 convencional | *Conventional D25 ceramic cartridge*

Cartucho cerámico D40 convencional 2 posiciones | *2 positions conventional D40 ceramic cartridge*

Cartucho cerámico progresivo | *Progressive ceramic cartridge*

Cartucho cerámico D40 salida libre 2 posiciones | *2 positions free flow D40 ceramic cartridge*

Cartucho cerámico D40 convencional | *Conventional D40 ceramic cartridge*

Cartucho cerámico D40 salida libre | *Free flow D40 ceramic cartridge*

Cartucho cerámico D35 convencional | *Conventional D35 ceramic cartridge*

Cartucho cerámico D35 salida libre | *Free flow D35 ceramic cartridge*

Cartucho cerámico D25 salida libre | *Free flow D25 ceramic cartridge*

Cartucho cerámico D40 junta superior salida libre 2 posiciones | *2 positions free flow D40 ceramic cartridge upper gasket*

Montura cerámica larga | *Ceramic long headwork*

Montura convencional larga | *Conventional long headwork*

Montura cerámica apertura derecha | *Clockwise opening ceramic headwork*

Montura cerámica larga apertura derecha | *Clockwise opening long ceramic headwork*

Montura empotrada 1 vía | *Single outlet headwork*

Recambios Spare parts



Montura
Headwork



Inversor | Diverter



Conexión flexible
Connection set



Conjunto sujección
Fixation set

Ref.:

67994 14

67995 14

68995 09

68995 11

100019

100069

100117 45

100158 45

100159 45

100160 45

100161 45

100162 45

100164 45

100165 45

100173 45

100174 45

9908 0032

9908 0035

100102

100103

100107

100116

100118

100119

100100

100105

9908 0047

9908 0048

9908 0049

9908 0050

100090

Descripción | Description

Montura empotrada 2 vías | *Double outlet headwork*

Montura cerámica T. | *T. Ceramic headwork*

Montura cerámica | *Ceramic headwork*

Montura convencional | *Conventional headwork*

Inversor monomando bidé | *Single lever bidet diverter*

Inversor cerámico columna termostática | *Thermostatic column ceramic diverter*

Inversor compacto | *Compact diverter*

Inversor termostático Kenjo | *Kenjo thermostatic diverter*

Inversor Lunic | *Lunic diverter*

Inversor ABS cromo | *ABS chromed diverter*

Inversor botón | *Button diverter*

Inversor cerámico largo baño empotrado | *Built-in large push-button diverter*

Inversor Tau cromo | *Tau chromed diverter*

Inversor semiautomático de latón cromo | *Brass chromed semi automatic diverter*

Inversor cerámico largo baño empotrado | *Built-in large push-button diverter*

Inversor convencional para batería bidet | *Bidet set conventional diverter*

Inversor columna redonda | *Round column diverter*

Inversor columna cuadrada | *Square column diverter*

Juego de conexiones nipple largo 10x1 - H 3/8" a 35 cm | *10x1 - F 3/8" 35 cm long nipple connection set*

Juego de conexiones 10x1 - H 3/8" a 35 cm | *10x1 - F 3/8" 35 cm connection set*

Juego de conexiones 10x1 - H 1/2" a 35 cm | *10x1 - F 1/2" 35 cm connection set*

Juego de conexiones 8x1 - H 3/8" a 35 cm | *8x1 - F 3/8" 35 cm connection set*

Juego de conexiones 10x1 - 15x1 | *10x1 - 15x1 connection set*

Juego de conexiones 8x1 - 15x1 | *8x1 - 15x1 connection set*

Juego de conexiones 10x1 - H 3/8" a 55 cm | *10x1 - F 3/8" 55 cm connection set*

Juego de conexiones 10x1 - H 3/8" a 40 cm | *10x1 - F 3/8" 40 cm connection set*

Conjunto sujección lavabo Oslo | *Oslo basin fixation set*

Conjunto sujección lavabo medio alto Oslo | *Oslo medium high basin fixation set*

Conjunto sujección lavabo alto Oslo | *Oslo high basin fixation set*

Conjunto sujección bidé Oslo | *Oslo bidet fixation set*

Conjunto sujección | *Fixation set*

Recambios Spare parts



Conjunto sujección
Fixation set

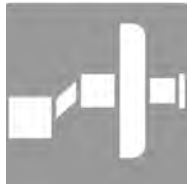

Conjunto excéntrica
Eccentric set



Placa | Tap plate

Ref.:

100091
100092
100095
100097
9908 0042

100122 45
100125 43
100125 45
100126 45
100127 45
100128 45
100114 45

PK115
PK116
PK131
PL115
PL116
PL131
PM111
PM113
PM114
PO113
PO115
PO117
PO118
PO131
PR113
PS115
PS116
PT113
PT115
PT116
PT117
PT118
PT131

Descripción | Description

Conjunto sujección 2 tornillos | 2 screws fixation set
Conjunto sujección Klip | Klip fixation set
Conjunto sujección Kenjo | Kenjo fixation set
Conjunto sujección fregadera extraíble | Pull-out sink tap fixation set
Conjunto sujección FRV61206 | FRV61206 fixation set

Conjunto florón y excéntricas gigantes | Giant scutcheon and eccentric set
Conjunto florón y excéntricas bronce | Bronze scutcheon and eccentric set
Conjunto florón y excéntricas | Scutcheon and eccentric set
Conjunto florón y excéntricas Redondo D60 | Round D60 scutcheon and eccentric set
Conjunto florón y excéntricas Redondo | Round scutcheon and eccentric set
Conjunto florón y excéntricas cuadrado | Square scutcheon and eccentric set
Conjunto florón y excéntricas oval | Oval scutcheon and eccentric set

Placa empotrar ducha | Built-in shower tap plate
Placa empotrar baño/ducha | Built-in bath/shower tap plate
Placa lavabo caño cuadrado | Square spout basin plate
Placa empotrar ducha | Built-in shower tap plate
Placa empotrar baño/ducha | Built-in bath/shower tap plate
Placa lavabo rectangular D35 | D35 rectangular basin plate
Placa empotrar termostática 3 vías | Built-in 2 way thermostatic tap plate
Placa empotrar termostática 1 vía | Built-in 1 way thermostatic tap plate
Placa empotrar termostática 2 vías | Built-in 3 way thermostatic tap plate
Placa inversor ovalada | Diverter oval plate
Placa empotrar ducha | Built-in shower tap plate
Placa ovalada inversor y palanca 2 vías | 2 way lever and diverter oval plate
Placa ovalada inversor y palanca 3 vías | 3 way lever and diverter oval plate
Placa lavabo ovalada | Oval basin plate
Placa inversor redonda | Diverter round plate
Placa empotrar ducha | Built-in shower tap plate
Placa empotrar baño/ducha | Built-in bath/shower tap plate
Placa inversor cuadrada | Diverter square plate
Placa empotrar ducha | Built-in shower tap plate
Placa empotrar baño/ducha | Built-in bath/shower tap plate
Placa rectangular inversor y palanca 2 vías | 2 way lever and diverter rectangular plate
Placa rectangular inversor y palanca 3 vías | 3 way lever and diverter rectangular plate
Placa lavabo rectangular | Rectangular basin plate

Recambios Spare parts



Set juntas
Gasket sets

Ref.:

9908 0030

9908 0033

J61

J65

J67

J68

J16

JFR

JFK

Descripción | Description

Set juntas columna redonda | *Round column gasket set*

Set juntas columna cuadrada | *Square column gasket set*

Set de juntas 61200 | *61200 gasket set*

Set de juntas R21 | *R21 gasket set*

Set de juntas 65702 | *65702 gasket set*

Set de juntas caño tubo | *Pipe spout gasket set*

Set de juntas R16 | *R16 gasket set*

Set de juntas FRT | *FRT gasket set*

Set de juntas FRK | *FRK gasket set*

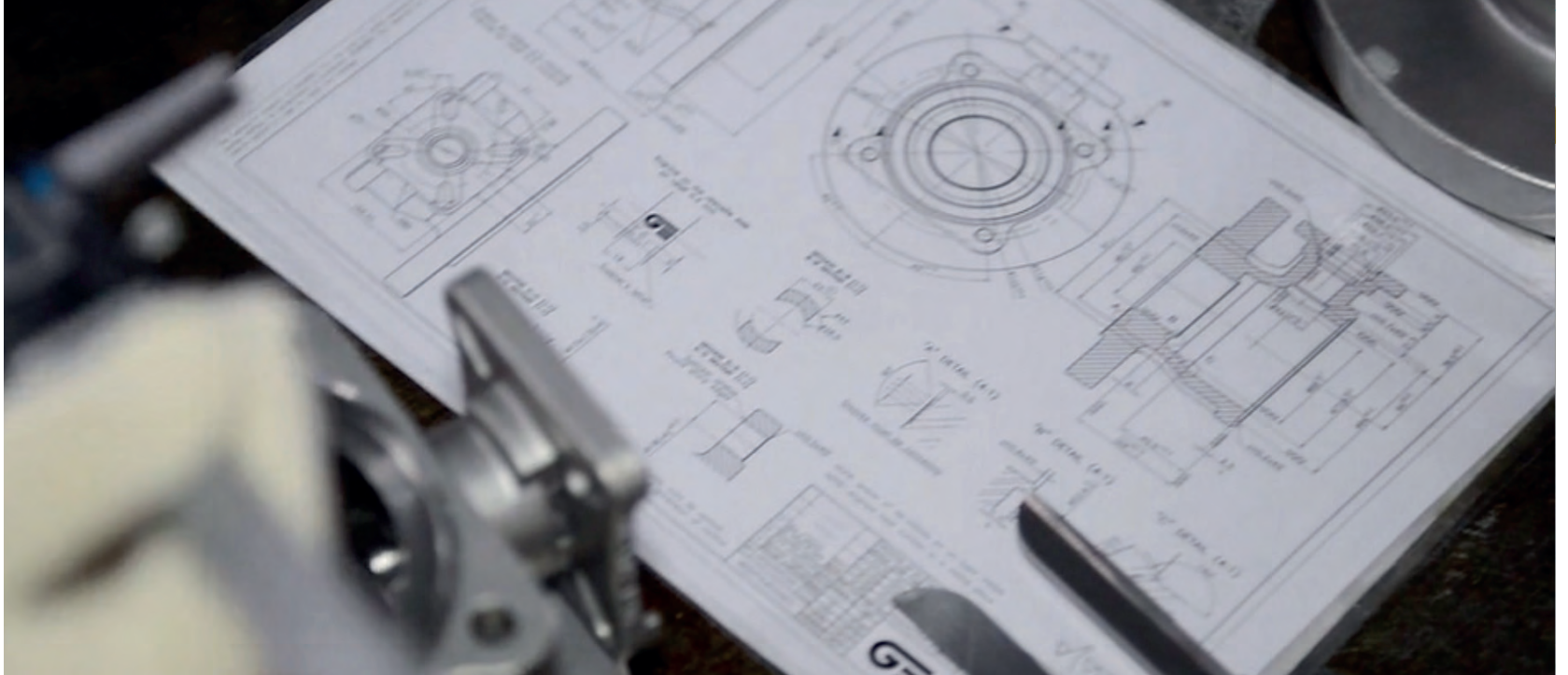

Información técnica

Technical Information

Consulta la ficha técnica de nuestros productos

Busque la referencia del artículo y encontrará toda la información técnica necesaria referente al producto.

Consult data sheet of our products

Locate the reference article and find all the technical information regarding the product.

Simbolos | Symbols



Información técnica | Technical information

serie Kode

Acabado cromado. Cartucho 40 | *Chromed finish. Cartridge 40*

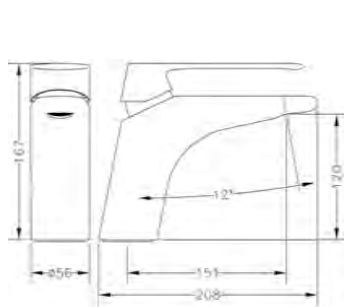

Ref.: 62130 08 45 66
Monomando de lavabo
Single lever wash-basin mixer

Box: 1 | Carton: 6 | Pallet: 192

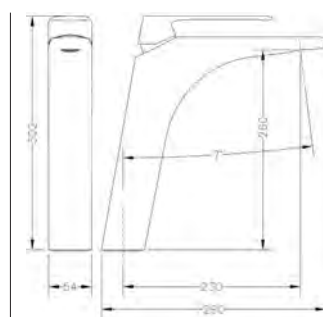

Ref.: 62136 08 45 66
Monomando de lavabo alto
High single lever wash-basin mixer

Box: 1 | Carton: 4 | Pallet: 96

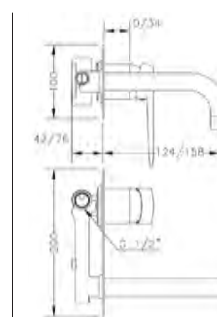

Ref.: 62131 31 45 66
Monomando de lavabo empotrado caño 16 cm
Built-in wash-basin mixer 16 cm spout

Box: 1 | Carton: 6 | Pallet: 144



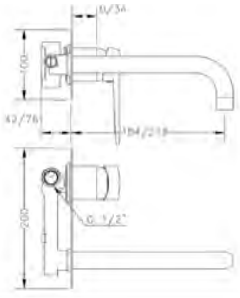

Ref.: 62132 31 45 66
 Monomando de lavabo empotrado caño 22 cm
Built-in wash-basin mixer 22 cm spout

Box: 1 | Carton: 6 | Pallet: 144



100049 | 100088 45 | 68925 45 | P0131 | 100001 31 45

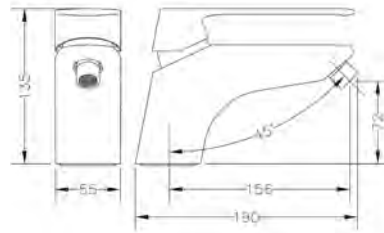

Ref.: 62140 08 45 66
 Monomando de bidé
Single lever bidet mixer

Box: 1 | Carton: 6 | Pallet: 192



100045 | 100103 | 100086 45 | 100092 | 100001 08 45

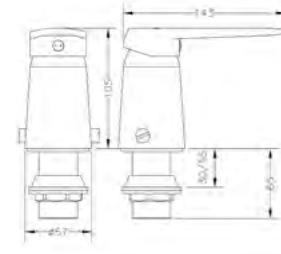

Ref.: 62142 31 45 66
 Monomando de bidé con transmisión
Single lever bidet mixer with diverter

Box: 1



100051 | 100107 | 100001 31 45 | 100019

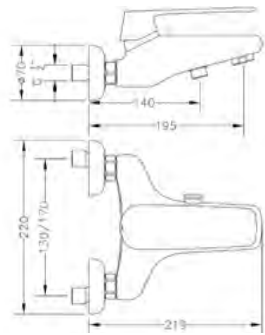

Ref.: 62100 08 45 67
 Monomando de baño sin kit
Single lever bath mixer without kit

Box: 1 | Carton: 6 | Pallet: 144



100045 | 100083 45 | 100161 45 | 100114 45 | 100001 08 45

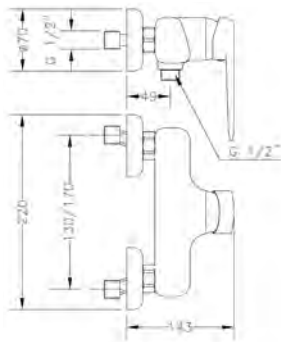

Ref.: 62110 31 45 67
 Monomando de ducha sin kit
Single lever shower mixer without kit

Box: 1 | Carton: 6 | Pallet: 192



100045 | 100001 31 45 | 100114 45

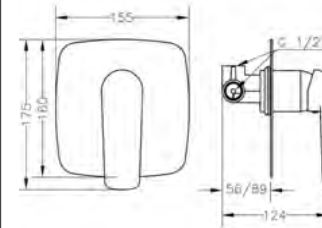

Ref.: 62115 31 45 66
 Monomando de ducha empotrado
Built-in single lever shower

Box: 1 | Carton: 8 | Pallet: 192



100049 | P0115 | 100001 31 45

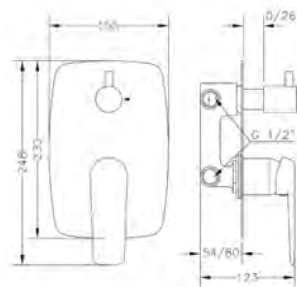

Ref.: 62117 31 45 66
 Monomando empotrado con inversor cerámico 2 vías
Built-in single handle mixer with 2 way ceramic diverter

Box: 1 | Carton: 6 | Pallet: 144



100049 | 9908 0024 | 68998 30 45 | 100001 31 45 | P0117

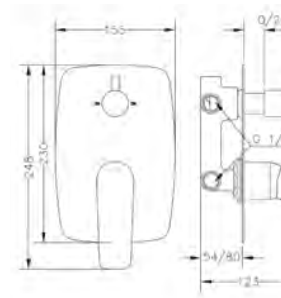

Ref.: 62118 08 45 66
 Monomando empotrado con inversor cerámico 3 vías
Built-in single handle mixer with 3 way ceramic diverter

Box: 1 | Carton: 6 | Pallet: 144



100049 | 9908 0025 | 68998 30 45 | 100001 31 45 | P0118

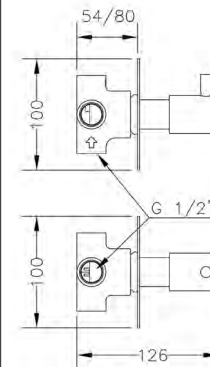

Ref.: 62114 30 45 66
 Inversor cerámico 3 vías empotrado con placa ovalada
Built-in 3 way ceramic diverter with oval plate

Box: 1 | Carton: 8 | Pallet: 384

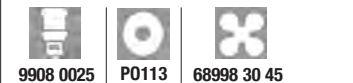

9908 0025 | P0113 | 68998 30 45

serie Oslo

Acabado cromado. Cartucho 35 | Chromed finish. Cartridge 35

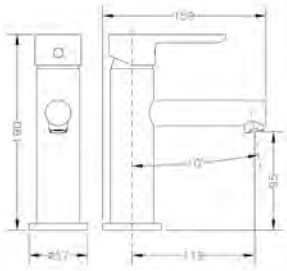

Ref.: 65130 19 45 66
Monomando de lavabo
Single lever wash-basin tap

Box: 1 | Carton: 12 | Pallet: 192

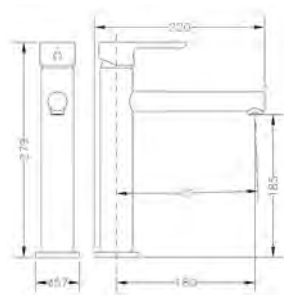

Ref.: 65134 19 45 66
Monomando de lavabo medio alto
Medium high single lever wash-basin mixer

Box: 1 | Carton: 10 | Pallet: 80

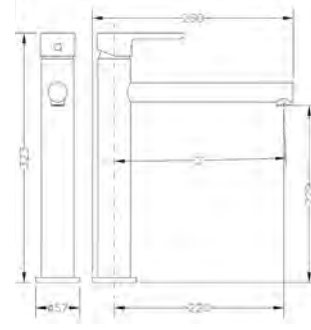

Ref.: 65136 19 45 66
Monomando de lavabo alto
High single lever wash-basin mixer

Box: 1 | Carton: 10 | Pallet: 80

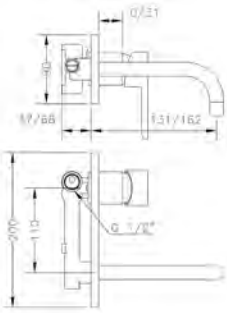

Ref.: 65131 19 45 66
Monomando de lavabo empotrado caño 16cm
Built-in wash-basin mixer 16 cm spout

Box: 1

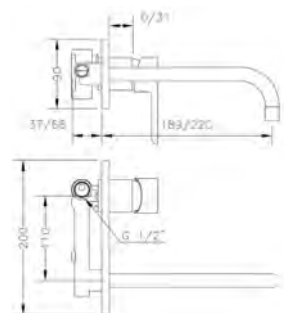
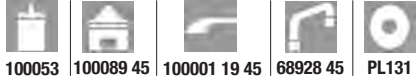

Ref.: 65132 19 45 66
Monomando de lavabo empotrado caño 22cm
Built-in wash-basin mixer 22 cm spout

Box: 1

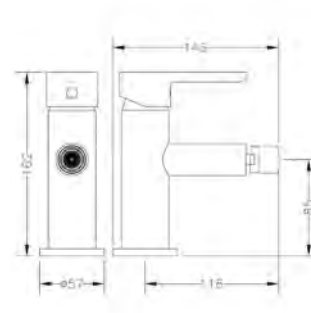

Ref.: 65140 19 45 66
Monomando de bidé
Single lever bidet mixer

Box: 1 | Carton: 12 | Pallet: 192

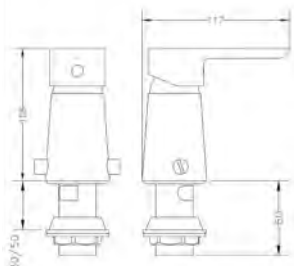

Ref.: 65142 19 45 66
Monomando de bidé con transmisión
Single lever bidet mixer with diverter

Box: 1 |



Ref.: 65100 19 45 66
Monomando de baño con kit
Single lever bath mixer with kit

Box: 1 | Carton: 8 | Pallet: 96

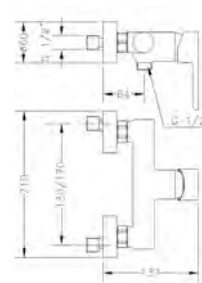

Ref.: 65110 19 45 66
Monomando de ducha con kit
Single lever shower mixer with kit

Box: 1 | Carton: 8 | Pallet: 96

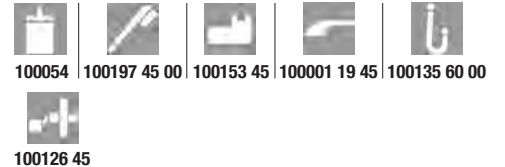

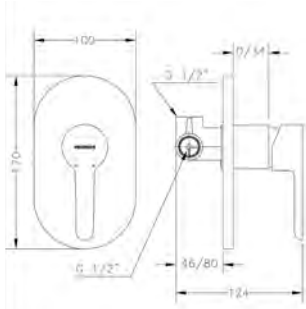

Ref.: 65115 19 45 66
 Monomando de ducha empotrado
Built-in single lever shower

Box: 1



100053 | PL115 | 100001 19 45

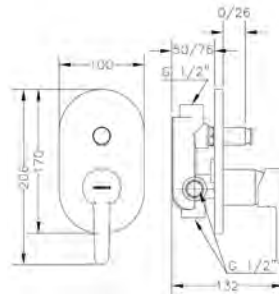

Ref.: 65116 19 45 66
 Monomando de baño empotrado con inversor
Built-in single lever bath with diverter

Box: 1



100053 | PL116 | 100001 19 45 | 100162 45

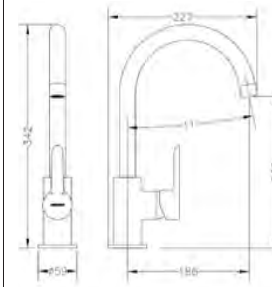

Ref.: 65203 19 45 66
 Monomando de fregadera
Single lever sink mixer

Box: 1



100053 | 100090 | 100103 | 100088 45 | 100001V 19 45 | J16

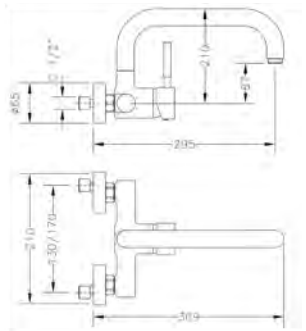

Ref.: 65192 19 45 66
 Monomando de fregadera mural 15 cm
Wall single lever sink mixer 15 cm

Box: 1



100054 | 100126 45 | 100088 45 | 100001V 19 45 | J16

serie Klip

Acabado cromado. Cartucho 40 | Chromed finish. Cartridge 40

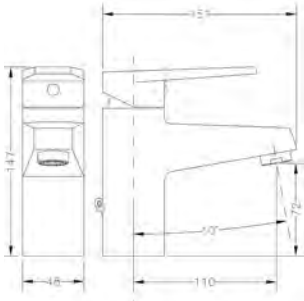

Ref.: 64130 16 45 66
 Monomando de lavabo
Single lever wash-basin mixer

Box: 1 | Carton: 20 | Pallet: 360

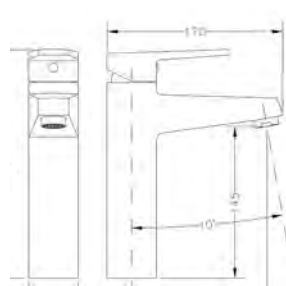

Ref.: 64134 16 45 66
 Monomando de lavabo medio alto
Medium high single lever wash-basin mixer

Box: 1 | Carton: 10 | Pallet: 180

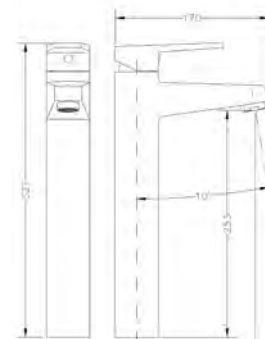

Ref.: 64136 16 45 66
 Monomando de lavabo alto
High single lever wash-basin mixer

Box: 1 | Carton: 6 | Pallet: 108

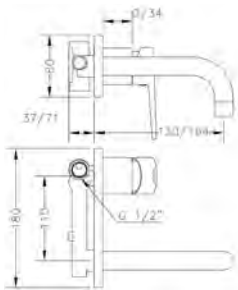

Ref.: 64131 16 45 66
 Monomando de lavabo empotrado caño 16 cm
Built-in wash-basin mixer 16 cm spout

Box: 1 | Carton: 6 | Pallet: 108

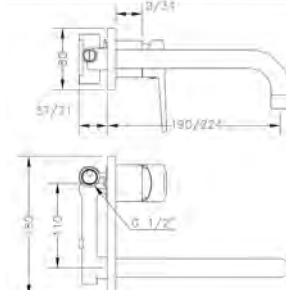

Ref.: 64132 16 45 66
 Monomando de lavabo empotrado caño 22 cm
Built-in wash-basin mixer 22 cm spout

Box: 1 | Carton: 6 | Pallet: 108

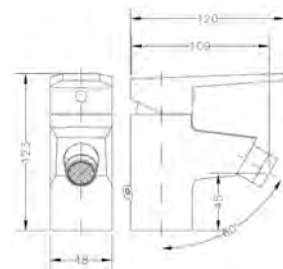

Ref.: 64140 16 45 66
 Monomando de bidé
Single lever bidet mixer

Box: 1 | Carton: 8 | Pallet: 480

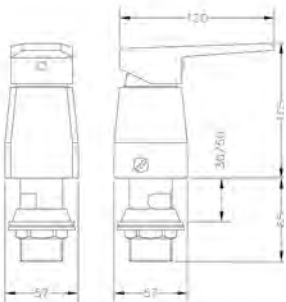

Ref.: 64142 16 45 66
 Monomando de bidé con transmisión
Single lever bidet mixer with diverter

Box: 1 | Carton: 12 | Pallet: 216

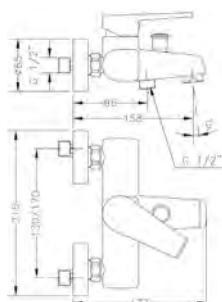
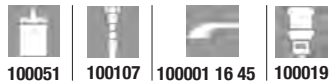

Ref.: 64100 16 45 66
 Monomando de baño con kit
Single lever bath mixer with kit

Box: 1 | Carton: 8 | Pallet: 96

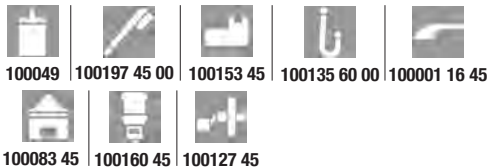

Ref.: 64110 16 45 66
 Monomando de ducha con kit
Single lever shower mixer with kit

Box: 1 | Carton: 8 | Pallet: 96

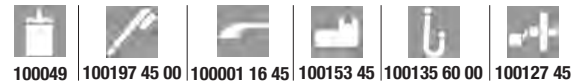

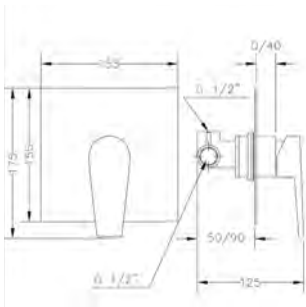

Ref.: 64115 16 45 66
 Monomando de ducha empotrado
Built-in single lever shower

Box: 1 | Carton: 12 | Pallet: 216



100049 | PT115 | 100001 16 45

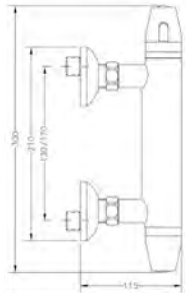

Ref.: 67104 14 45 67
 Termostática ducha
Thermostatic shower

Box: 1 | Carton: 12 | Pallet: 288



100037 | 67995 14 | 68994 14 | 100126 45

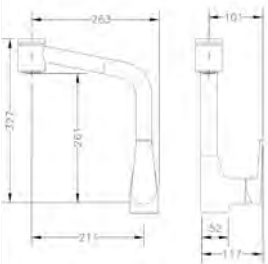

Ref.: 64206 16 45 66
 Monomando de fregadera ducha extraíble
Single lever sink mixer with pull-out spray

Box: 1 | Carton: 6 | Pallet: 108



100103 | 100143 45 | 100252 45 | 100001V 16 45 | 100049 | 100118



100097 | 100085

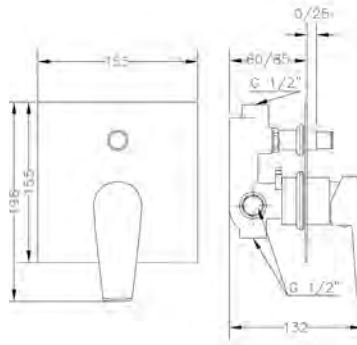

Ref.: 64116 16 45 66
 Monomando de baño empotrado con inversor
Built-in single lever bath with diverter

Box: 1 | Carton: 12 | Pallet: 216



100049 | 100162 45 | PT116 | 100001 16 45

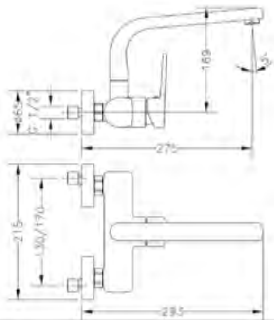

Ref.: 64192 16 45 66
 Monomando de fregadera mural
Wall single lever sink mixer

Box: 1 | Carton: 6 | Pallet: 72



100049 | 100127 45 | 100001V 16 45 | 100085 45

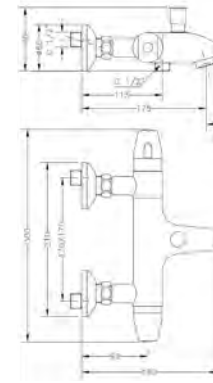

Ref.: 67103 14 45 67
 Termostática baño
Thermostatic bath

Box: 1 | Carton: 6 | Pallet: 144



100037 | 67995 14 | 68994 14 | 100126 45 | 100165 45 | 100083

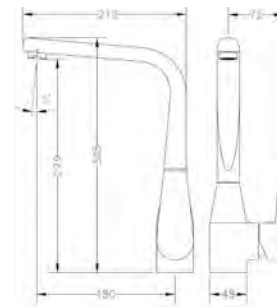

Ref.: 64201 16 45 66
 Monomando de fregadera
Single lever sink mixer

Box: 1 | Carton: 6 | Pallet: 108



100049 | 100103 | 100001V 16 45 | 100092 | 100085 45 | J65

serie Klip 2

Acabado cromado. Cartucho 40 | Chromed finish. Cartridge 40

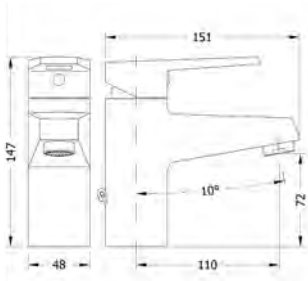

Ref.: 64130 14 45 66
 Monomando de lavabo
Single lever wash-basin mixer

Box: 1 | Carton: 20 | Pallet: 360

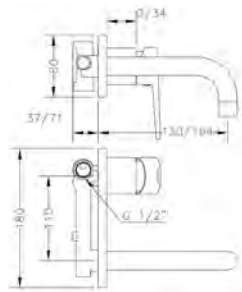

Ref.: 64131 14 45 66
 Monomando de lavabo empotrado caño 16 cm
Built-in wash-basin mixer 16 cm spout

Box: 1 | Carton: 6 | Pallet: 108



Ref.: 64142 14 45 66
 Monomando de bidé con transmisión
Single lever bidet mixer with diverter

Box: 1 | Carton: 12 | Pallet: 216

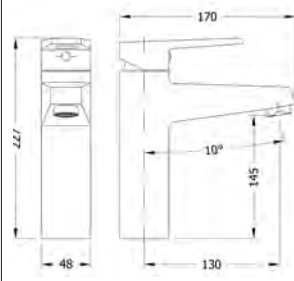

Ref.: 64134 14 45 66
 Monomando de lavabo medio alto
Medium high single lever wash-basin mixer

Box: 1 | Carton: 10 | Pallet: 180

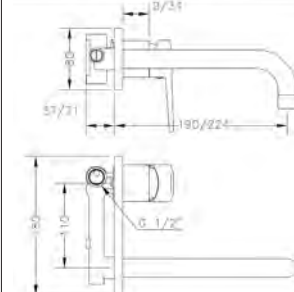

Ref.: 64132 14 45 66
 Monomando de lavabo empotrado caño 22 cm
Built-in wash-basin mixer 22 cm spout

Box: 1 | Carton: 6 | Pallet: 108

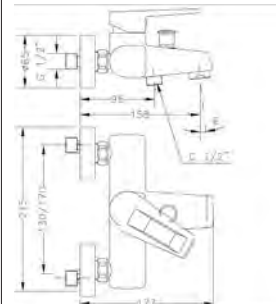

Ref.: 64100 14 45 66
 Monomando de baño con kit
Single lever bath mixer with kit

Box: 1 | Carton: 8 | Pallet: 128

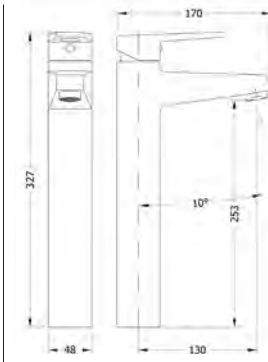
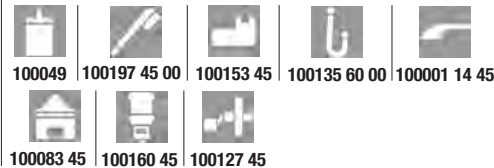

Ref.: 64136 14 45 66
 Monomando de lavabo alto
High single lever wash-basin mixer

Box: 1 | Carton: 6 | Pallet: 108

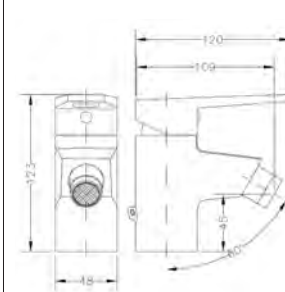

Ref.: 64140 14 45 66
 Monomando de bidé
Single lever bidet mixer

Box: 1 | Carton: 8 | Pallet: 480

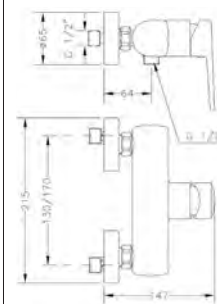

Ref.: 64110 14 45 66
 Monomando de ducha con kit
Single lever shower mixer with kit

Box: 1 | Carton: 8 | Pallet: 96

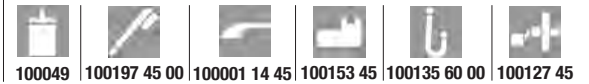

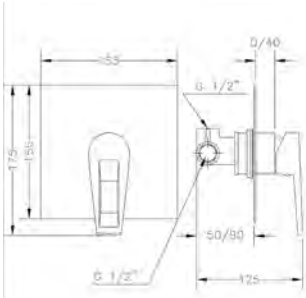

Ref.: 64115 14 45 66
 Monomando de ducha empotrado
Built-in single lever shower

Box: 1 | Carton: 12 | Pallet: 216



100049 | PT115 | 100001 14 45

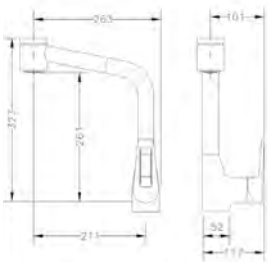

Ref.: 64206 14 45 66
 Monomando de fregadera ducha extraíble
Single lever sink mixer with pull-out spray

Box: 1 | Carton: 6 | Pallet: 108



100103 | 100001V 14 45 | 100143 45 | 100252 45 | 100049



100118 | 100097 | 100085

serie Kelogic

Acabado cromado. Cartucho 40 | *Chromed finish. Cartridge 40*



Ref.: 64130 04 45 66
 Monomando de lavabo apertura en frío
Single lever wash-basin mixer cold start

Box: 1 | Carton: 20 | Pallet: 360



100048 | 100103 | 100074 45 | 100092 | 100001F 16 45

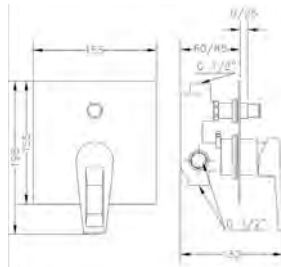

Ref.: 64116 14 45 66
 Monomando de baño empotrado con invector
Built-in single lever bath with diverter

Box: 1 | Carton: 12 | Pallet: 216



100049 | 100162 45 | PT116 | 100001 14 45

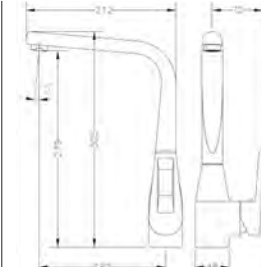

Ref.: 64201 14 45 66
 Monomando de fregadera
Single lever sink mixer

Box: 1 | Carton: 6 | Pallet: 108



100049 | 100001V 14 45 | 100103 | 100092 | 100085 45 | J65

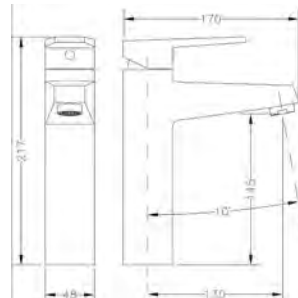

Ref.: 64134 04 45 66
 Monomando de lavabo medio alto apertura en frío
Medium high single lever wash-basin mixer cold start

Box: 1 | Carton: 10 | Pallet: 180



100048 | 100103 | 100074 45 | 100092 | 100001F 16 45

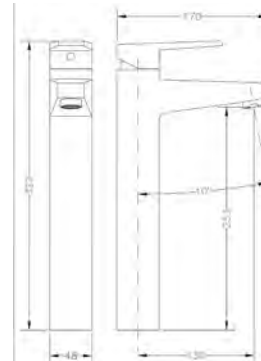

Ref.: 64136 04 45 66
 Monomando de lavabo alto apertura en frío
High single lever wash-basin mixer cold start

Box: 1 | Carton: 6 | Pallet: 108



100048 | 100103 | 100074 45 | 100092 | 100001F 16 45

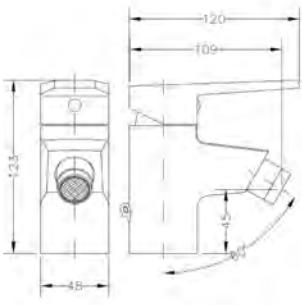

Ref.: 64140 04 45 66
 Monomando de bidé apertura en frío
Single lever bidet mixer cold start

Box: 1 | Carton: 8 | Pallet: 480

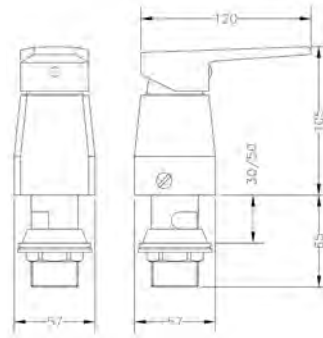

Ref.: 64142 04 45 66
 Monomando de bidé con transmisión
Single lever bidet mixer with diverter

Box: 1 | Carton: 12 | Pallet: 216

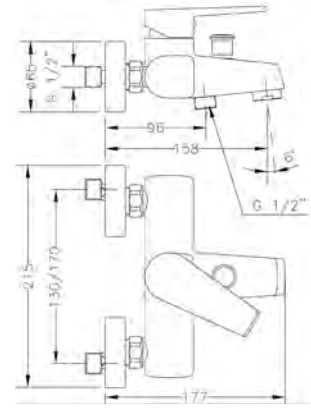

Ref.: 64100 04 45 66
 Monomando de baño con kit
Single lever bath mixer with kit

Box: 1 | Carton: 8 | Pallet: 96

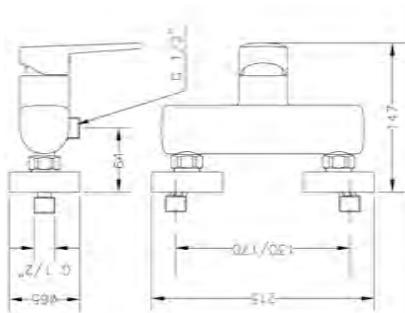
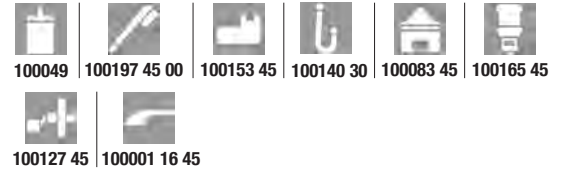

Ref.: 64110 04 45 66
 Monomando de ducha con kit
Single lever shower mixer with kit

Box: 1 | Carton: 8 | Pallet: 96

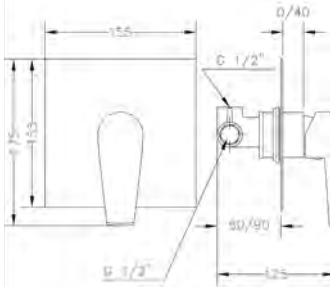

Ref.: 64115 16 45 66
 Monomando de ducha empotrado
Built-in single lever shower

Box: 1 | Carton: 12 | Pallet: 216

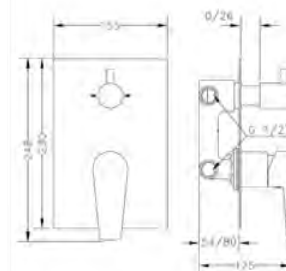

Ref.: 64117 04 45 66
 Monomando empotrado con inversor cerámico 2 vías
Built-in single handle mixer with 2 way ceramic diverter

Box: 1 | Carton: 6 | Pallet: 144

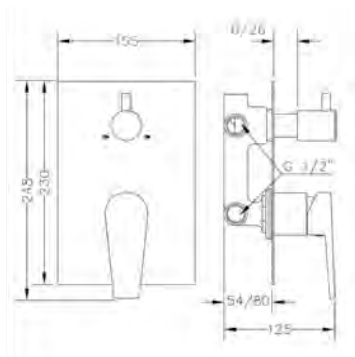

Ref.: 64118 04 45 66
 Monomando empotrado con inversor cerámico 3 vías
Built-in single handle mixer with 3 way ceramic diverter

Box: 1 | Carton: 6 | Pallet: 144

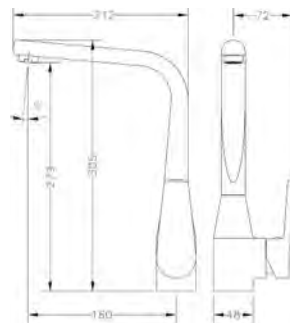

Ref.: 64201 04 45 66
 Monomando de fregadera apertura en frío
Single lever sink mixer cold start

Box: 1 | Carton: 6 | Pallet: 108



serie Tau

Acabado cromado. Cartucho 40 | *Chromed finish. Cartridge 40*

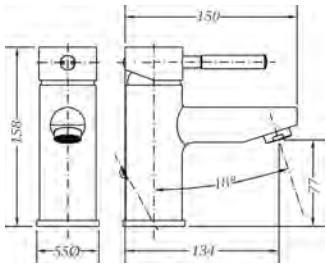

Ref.: 65135 18 45 66
 Monomando de lavabo
Single lever wash-basin tap

Box: 1 | Carton: 12 | Pallet: 216



100051 100103 100001 18 45 100085 45 100091

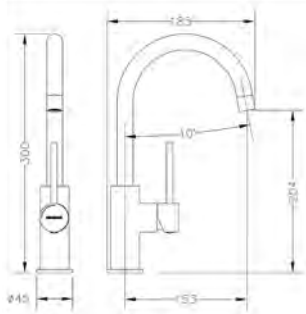

Ref.: 65138 18 45 66
 Monomando de lavabo
Single lever wash-basin tap

Box: 1

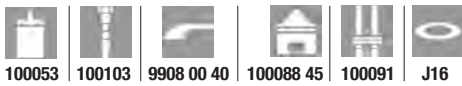

100053 100103 9908 00 40 100088 45 100091 J16

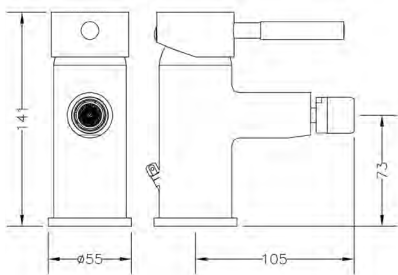

Ref.: 65145 18 45 66
 Monomando de bidé
Single lever bidet mixer

Box: 1 | Carton: 8 | Pallet: 384



100051 100103 100086 45 100001 18 45 100091

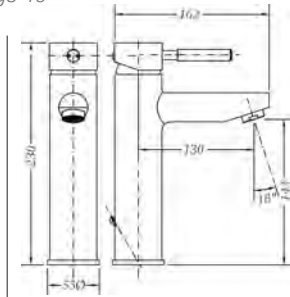

Ref.: 65134 18 45 66
 Monomando de lavabo medio alto
Medium high single lever wash-basin mixer

Box: 1 | Carton: 10 | Pallet: 180

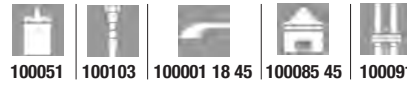

100051 100103 100001 18 45 100085 45 100091

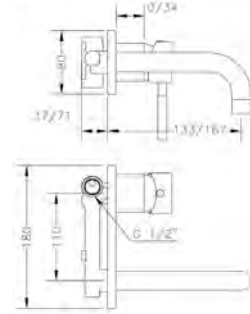

Ref.: 65131 18 45 66
 Monomando de lavabo empotrado caño 16cm
Built-in wash-basin mixer 16 cm spout

Box: 1 | Carton: 6 | Pallet: 144



100049 100088 45 100001 18 45 68924 45 PT131

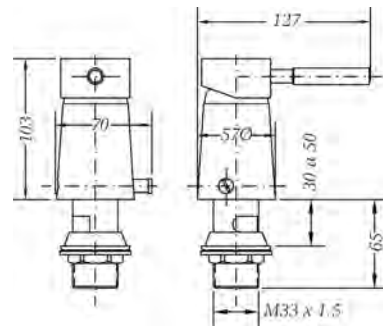

Ref.: 65142 18 45 66
 Monomando de bidé con transmisión
Single lever bidet mixer with diverter

Box: 1 | Carton: 12 | Pallet: 216



100051 100107 100001 18 45 1000019

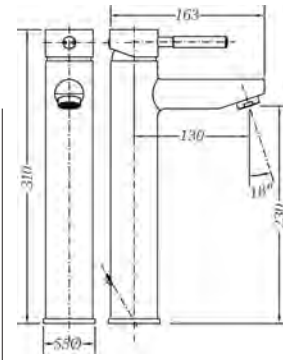

Ref.: 65136 18 45 66
 Monomando de lavabo alto
High single lever wash-basin mixer

Box: 1 | Carton: 6 | Pallet: 108



100051 100103 100001 18 45 100085 45 100091

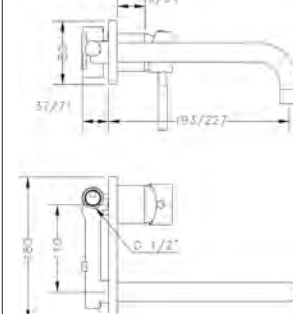

Ref.: 65132 18 45 66
 Monomando de lavabo empotrado caño 22cm
Built-in wash-basin mixer 22 cm spout

Box: 1 | Carton: 6 | Pallet: 144



100049 100088 45 100001 18 45 68925 45 PT131

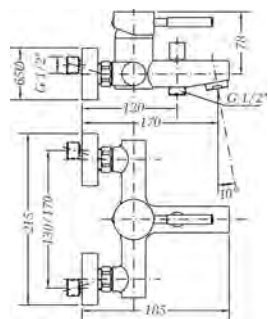

Ref.: 65100 18 45 66
 Monomando de baño con kit
Single lever bath mixer with kit

Box: 1 | Carton: 6 | Pallet: 108

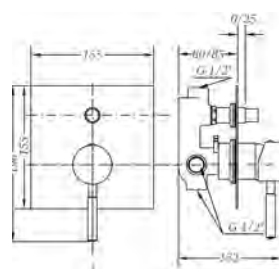

Ref.: 65116 18 45 66
 Monomando de baño empotrado con inversor
Built-in single lever bath with diverter

Box: 1 | Carton: 12 | Pallet: 216

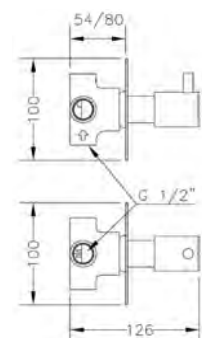

Ref.: 65114 30 45 66
 Inversor cerámico 3 vías empotrado con placa cuadrada
Built-in 3 way ceramic diverter With square plate

Box: 1 | Carton: 8 | Pallet: 384

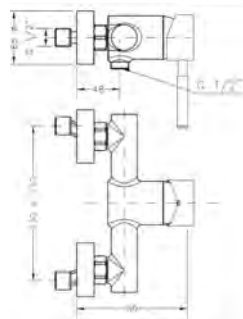

Ref.: 65110 18 45 66
 Monomando de ducha con kit
Single lever shower mixer with kit

Box: 1 | Carton: 6 | Pallet: 108

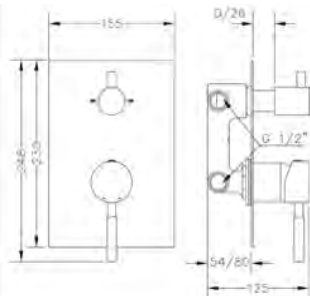
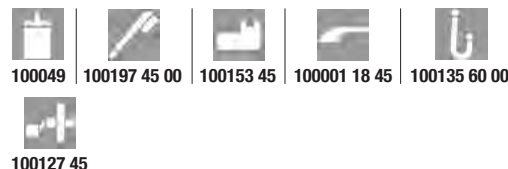

Ref.: 65117 18 45 66
 Monomando empotrado con inversor cerámico 2 vías
Built-in single handle mixer with 2 way ceramic diverter

Box: 1 | Carton: 6 | Pallet: 144

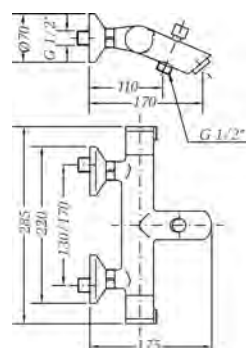

Ref.: 67102 14 45 67
 Termostática baño
Thermostatic bath

Box: 1 | Carton: 6 | Pallet: 144

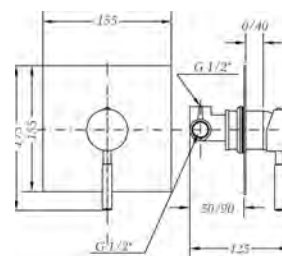

Ref.: 65115 18 45 66
 Monomando de ducha empotrado
Built-in single lever shower

Box: 1 | Carton: 12 | Pallet: 216

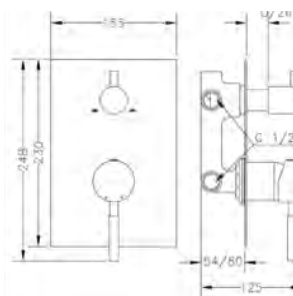
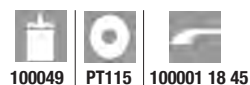

Ref.: 65118 18 45 66
 Monomando empotrado con inversor cerámico 3 vías
Built-in single handle mixer with 3 way ceramic diverter

Box: 1 | Carton: 6 | Pallet: 144

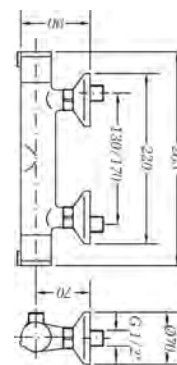

Ref.: 67112 14 45 67
 Termostática ducha
Thermostatic shower

Box: 1 | Carton: 6 | Pallet: 144



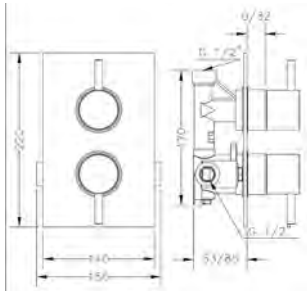

Ref.: 64113 14 45 67
 Termostática empotrada 1 salida
 Built-in thermostatic 1 outlet

Box: 1 | Carton: 4 | Pallet: 64

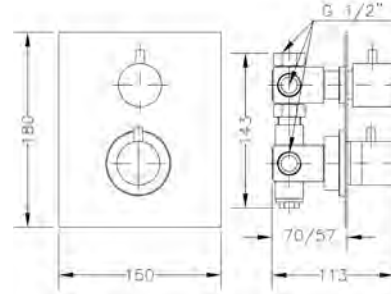

Ref.: 64114 14 45 67
 Termostática empotrada 2 salidas
 Built-in thermostatic 2 outlets

Box: 1 | Carton: 4 | Pallet: 64

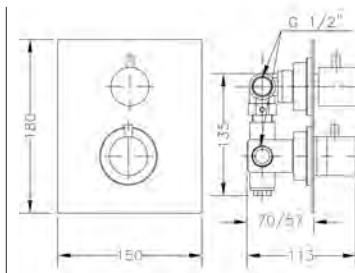

Ref.: 64111 14 45 67
 Termostática empotrada 3 salidas
 Built-in thermostatic 3 outlets

Box: 1 | Carton: 4 | Pallet: 64

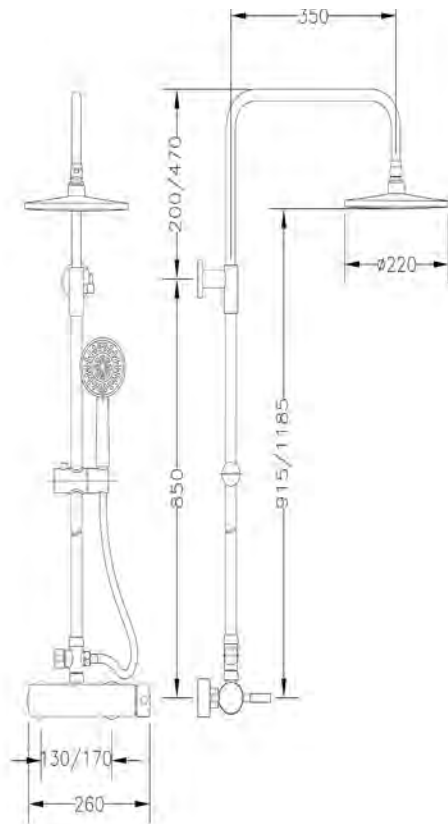

Ref.: CM65110 18
 Columna monomando extensible con kit
 Single lever extensible column with kit

Box: 1 | Carton: 2 | Pallet: 8

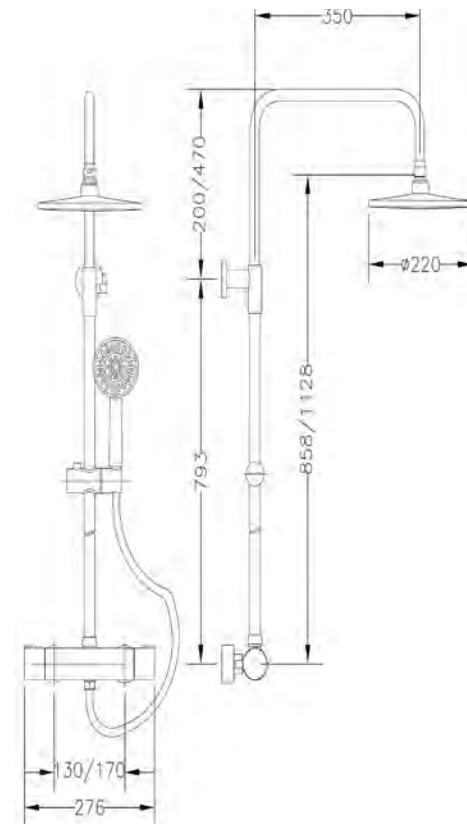
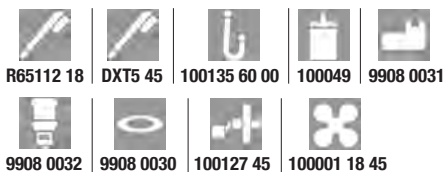

Ref.: CT67110 18
 Columna termostática extensible con kit
 Thermostatic extensible column with kit

Box: 1 | Carton: 2 | Pallet: 8

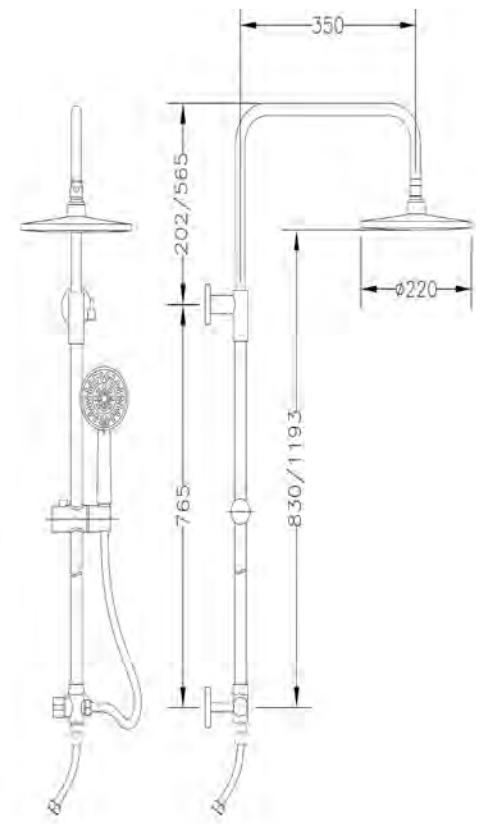

Ref.: 1745 45
 Set columna extensible con ducha, soporte y flexo
 Extensible column set with shower, holder and flexible hose

Box: 1 | Carton: 2 | Pallet: 8



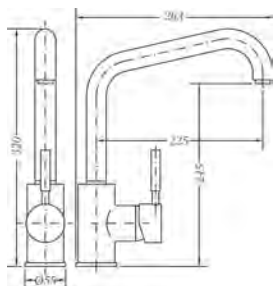

Ref.: 65204 18 45 66
 Monomando de fregadera
 Single lever sink mixer

Box: 1 | Carton: 5 | Pallet: 90

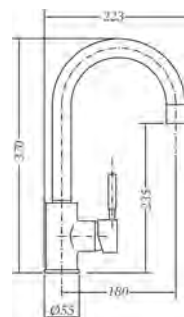
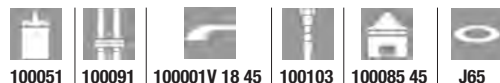

Ref.: 65203 18 45 66
 Monomando de fregadera
 Single lever sink mixer

Box: 1 | Carton: 5 | Pallet: 90

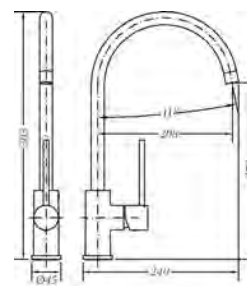
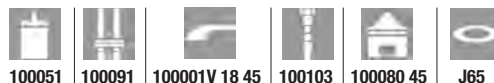

Ref.: FRT65401
 Monomando de fregadera cartucho 25
 Single lever sink mixer cartridge 25

Box: 1 | Carton: 8 | Pallet: 96

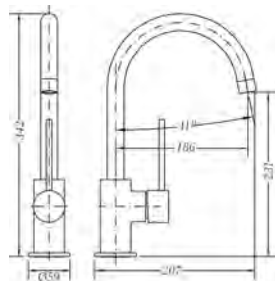
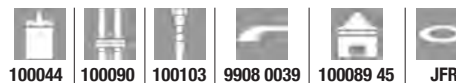

Ref.: FRT65402
 Monomando de fregadera cartucho 35
 Single lever sink mixer cartridge 35

Box: 1 | Carton: 8 | Pallet: 96

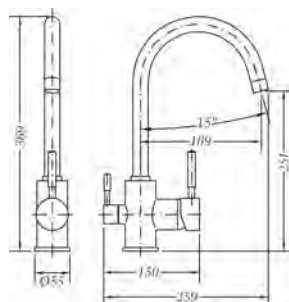
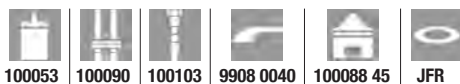

Ref.: 65702 18 45 66
 Monomando de fregadera Osmosis cartucho 35
 Single lever sink Osmosis mixer 35 cartridge

Box: 1 | Carton: 4 | Pallet: 96

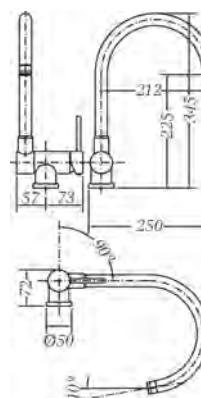
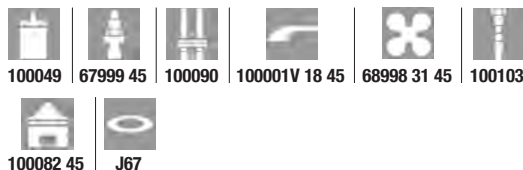

Ref.: 65900 18 45 66
 Monomando de fregadera abatible cartucho 35
 Single lever folding sink mixer 35 cartridge

Box: 1 | Carton: 8 | Pallet: 96

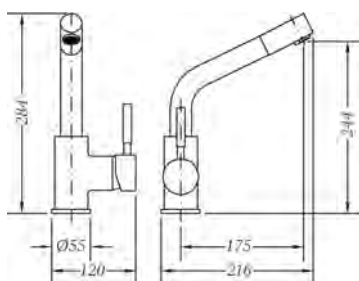

Ref.: 65206 18 45 66
 Monomando de fregadera caño extraíble
 Single lever sink mixer with pull-out spout

Box: 1 | Carton: 8 | Pallet: 192

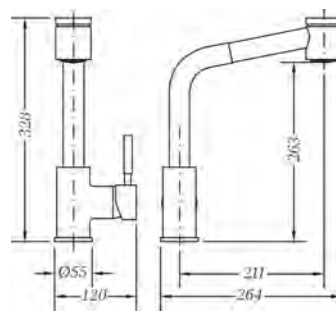

Ref.: 65205 18 45 66
 Monomando de fregadera ducha extraíble
 Single lever sink mixer with pull-out spray

Box: 1 | Carton: 6 | Pallet: 108

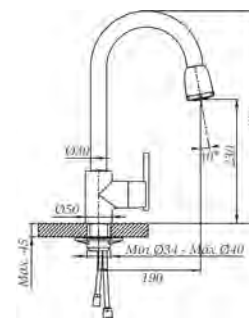

Ref.: FRV61205
 Monomando de fregadera ducha extraíble
 Single lever sink mixer with pull-out spray

Box: 1 | Carton: 8 | Pallet: 108

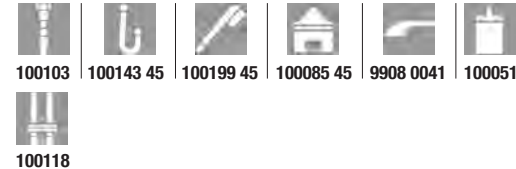

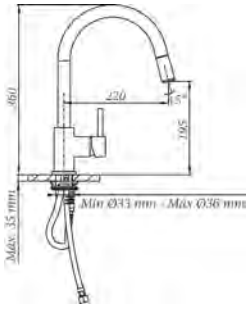

Ref.: FRV61206
 Monomando de fregadera caño extraíble
Single-lever sink mixer with pull-out spout

Box: 1 | Carton: 8 | Pallet: 96

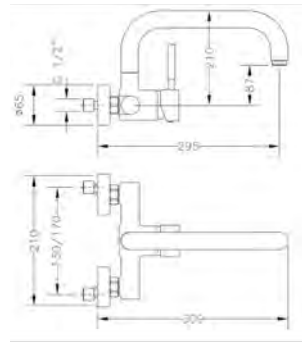

Ref.: 65192 18 45 66
 Monomando de fregadera mural 15 cm
Wall single lever sink mixer 15 cm

Box: 1 | Carton: 4 | Pallet: 72



serie Tau 2

Acabado cromado. Cartucho 40 | *Chromed finish. Cartridge 40*

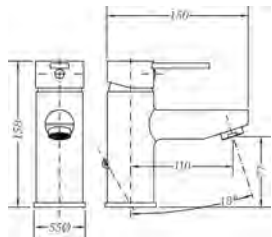

Ref.: 65135 29 45 66
 Monomando de lavabo
Single lever wash-basin mixer

Box: 1 | Carton: 12 | Pallet: 216

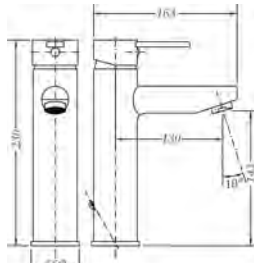

Ref.: 65134 29 45 66
 Monomando de lavabo medio alto
Medium high single lever wash-basin mixer

Box: 1 | Carton: 10 | Pallet: 180

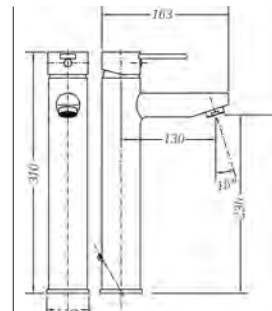

Ref.: 65136 29 45 66
 Monomando de lavabo alto
High single lever wash-basin mixer

Box: 1 | Carton: 6 | Pallet: 108

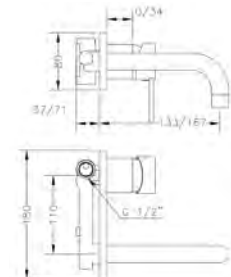

Ref.: 65131 29 45 66
 Monomando de lavabo empotrado caño 16cm
Built-in wash-basin mixer 16 cm spout

Box: 1 | Carton: 6 | Pallet: 108

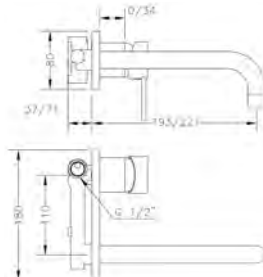

Ref.: 65132 29 45 66
 Monomando de lavabo empotrado caño 22cm
Built-in wash-basin mixer 22 cm spout

Box: 1 | Carton: 6 | Pallet: 108

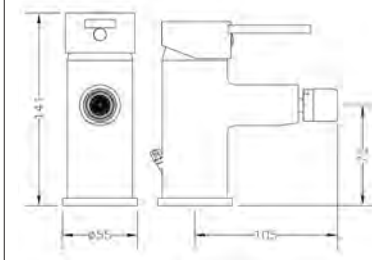

Ref.: 65145 29 45 66
 Monomando de bidé
Single lever bidet mixer

Box: 1 | Carton: 12 | Pallet: 216



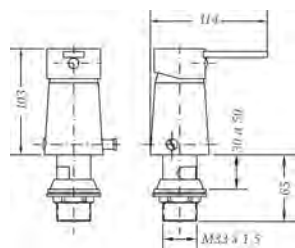

Ref.: 65142 29 45 66
 Monomando de bidé con transmisión
Single lever bidet mixer with diverter

Box: 1 | Carton: 12 | Pallet: 216



100051 | 1000019 | 100001 29 45 | 100107

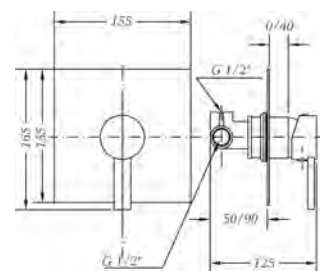

Ref.: 65115 29 45 66
 Monomando de ducha empotrado
Built-in single lever shower

Box: 1 | Carton: 12 | Pallet: 216



100049 | PT115 | 100001 29 45

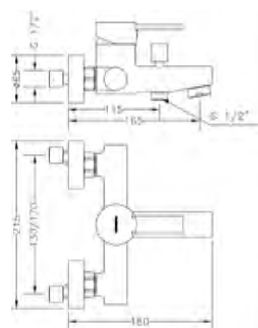

Ref.: 65100 29 45 66
 Monomando de baño con kit
Single lever bath mixer with kit

Box: 1 | Carton: 6 | Pallet: 108



100049 | 100197 45 00 | 100153 45 | 100135 60 00 | 100001 29 45



100083 45 | 100164 45 | 100127 45

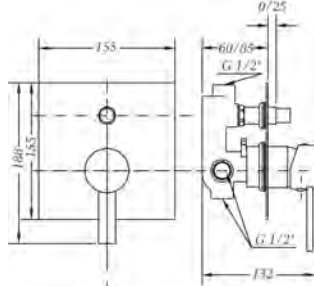

Ref.: 65116 29 45 66
 Monomando de baño empotrado con inversor
Built-in single lever bath with diverter

Box: 1 | Carton: 12 | Pallet: 216



100049 | 100162 45 | PT116 | 100001 29 45

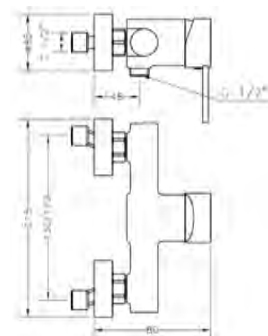

Ref.: 65110 29 45 66
 Monomando de ducha con kit
Single lever shower mixer with kit

Box: 1 | Carton: 6 | Pallet: 108



100049 | 100197 45 00 | 100153 45 | 100001 29 45 | 100135 60 00



100127 45

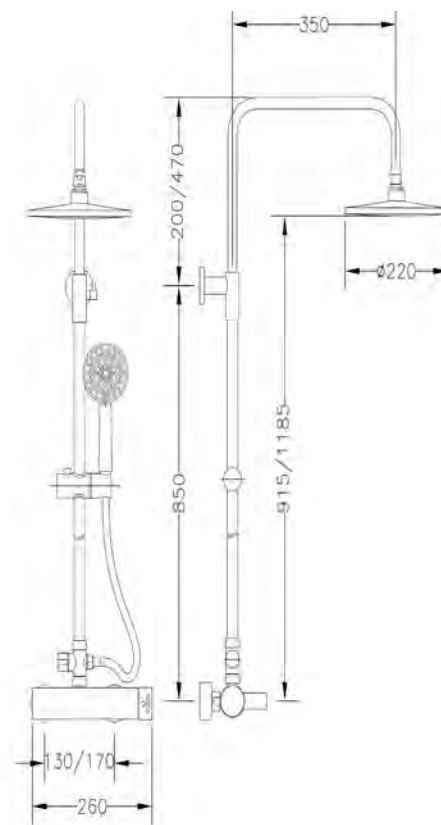

Ref.: CM65110 29
 Columna monomando extensible con kit
Single lever extensible column with kit

Box: 1 | Carton: 2 | Pallet: 8



R65112 18 | DXT5 45 | 100135 60 00 | 9908 0031 | 9908 0032



9908 0030 | 100049 | 100001 29 45 | 100127 45

serie Kenjo

Acabado cromado. Cartucho 35 | *Chromed finish. Cartridge 35*

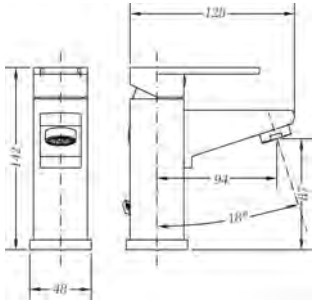

Ref.: 63130 26 45 66
 Monomando de lavabo
Single lever wash-basin mixer

Box: 1 | Carton: 20 | Pallet: 360

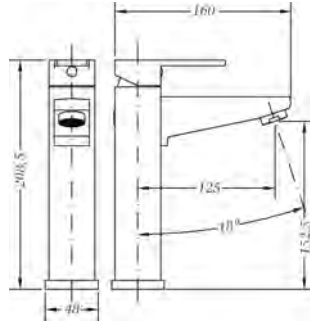

Ref.: 63134 26 45 66
 Monomando de lavabo medio alto
Medium high single lever wash-basin mixer

Box: 1 | Carton: 8 | Pallet: 192

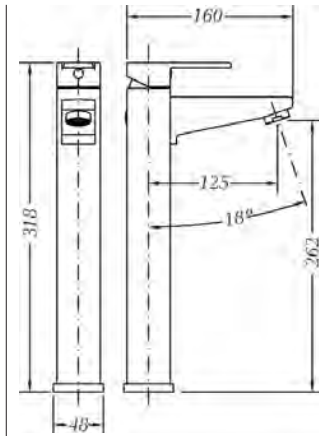

Ref.: 63136 26 45 66
 Monomando de lavabo alto
High single lever wash-basin mixer

Box: 1 | Carton: 6 | Pallet: 108

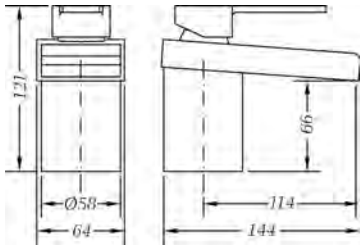

Ref.: 63137 26 45 66
 Monomando de lavabo cascada
Waterfall single lever wash-basin mixer

Box: 1 | Carton: 20 | Pallet: 360

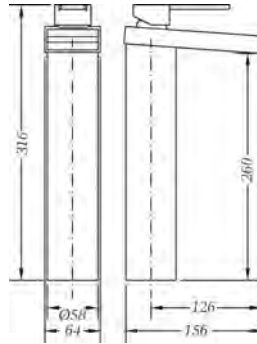

Ref.: 63138 26 45 66
 Monomando de lavabo cascada alto
High waterfall single lever wash-basin mixer

Box: 1 | Carton: 6 | Pallet: 108

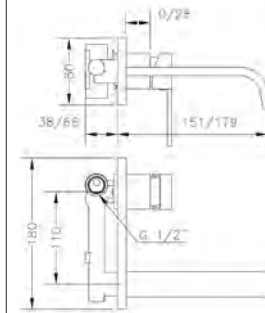

Ref.: 63131 26 45 66
 Monomando de lavabo empotrado caño 16cm
Built-in wash-basin mixer 16 cm spout

Box: 1 | Carton: 6 | Pallet: 108

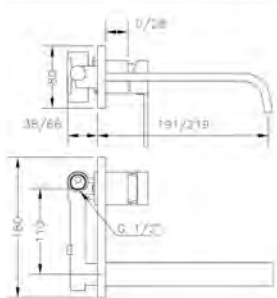

Ref.: 63132 26 45 66
 Monomando de lavabo empotrado caño 22cm
Built-in wash-basin mixer 22 cm spout

Box: 1 | Carton: 6 | Pallet: 108

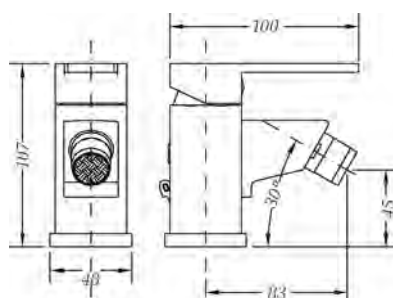
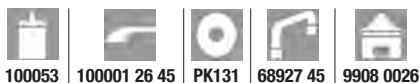

Ref.: 63140 26 45 66
 Monomando de bidé
Single lever bidet mixer

Box: 1 | Carton: 20 | Pallet: 360

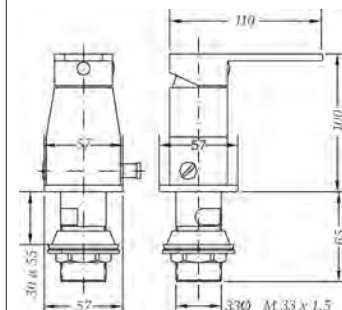

Ref.: 63142 26 45 66
 Monomando de bidé con transmisión
Single lever bidet mixer with diverter

Box: 1 | Carton: 12 | Pallet: 216



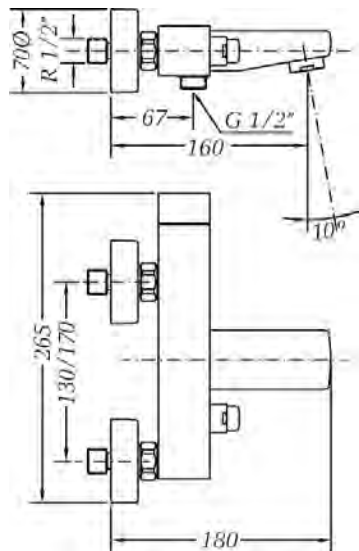

Ref.: 63100 26 45 67
 Monomando de baño sin kit
Single lever bath mixer without kit

Box: 1 | Carton: 6 | Pallet: 108



100053 100083 45 100161 45 100128 45 100001 27 45

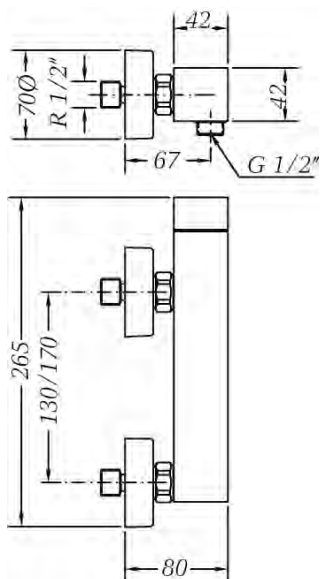

Ref.: 63110 26 45 67
 Monomando de ducha sin kit
Single lever shower mixer without kit

Box: 1 | Carton: 10 | Pallet: 180



100053 100128 100001 27 45

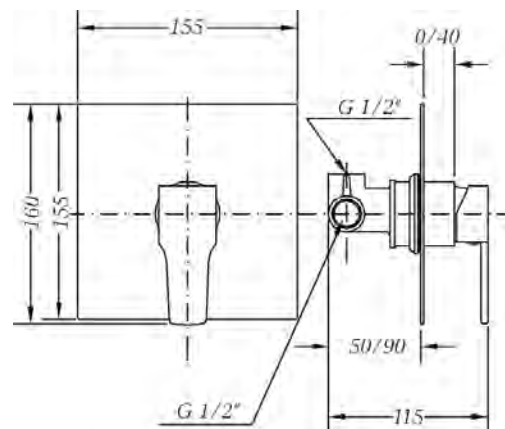

Ref.: 63115 26 45 66
 Monomando de ducha empotrado
Built-in single lever shower

Box: 1 | Carton: 12 | Pallet: 216



100053 PK115 100001 26 45

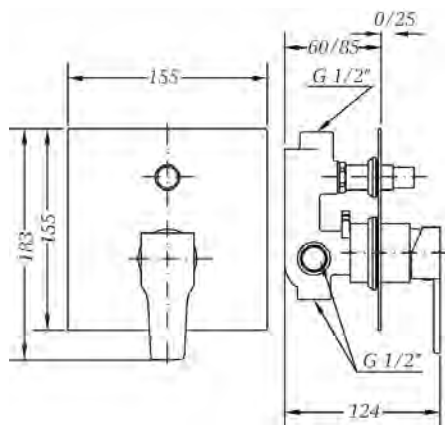

Ref.: 63116 26 45 66
 Monomando de baño empotrado con inversor
Built-in single lever bath with diverter

Box: 1 | Carton: 12 | Pallet: 216



100053 100162 45 100001 26 45 PK116

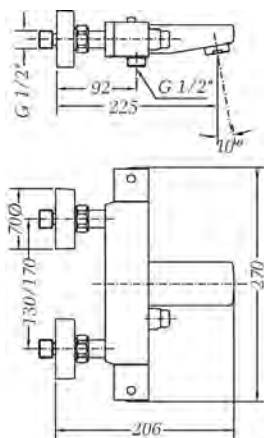

Ref.: 67100 26 45 67
 Termostática de baño sin kit
Thermostatic bath without kit

Box: 1 | Carton: 6 | Pallet: 288



100037 67991 26 68992 26 100158 45 100128 45 100083 45

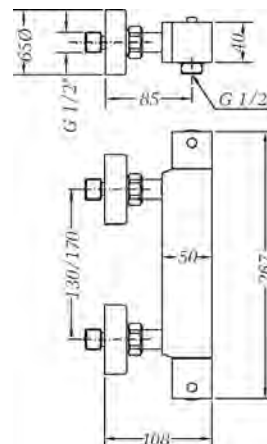

Ref.: 67110 26 45 67
 Termostática ducha sin kit
Thermostatic shower without kit

Box: 1 | Carton: 9 | Pallet: 216



100037 67991 26 68992 26 100126 45

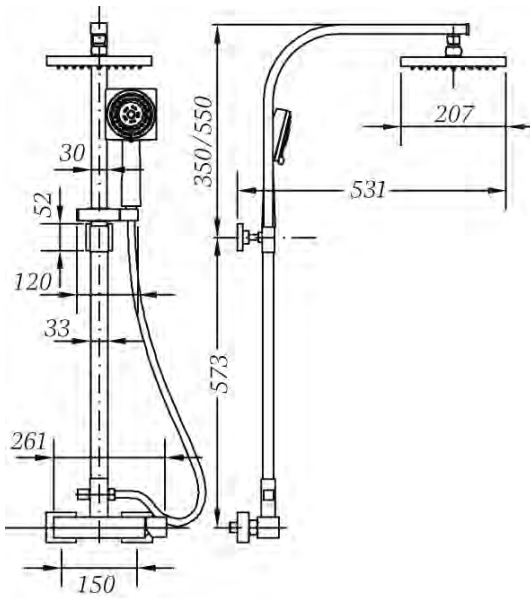

Ref.: CM63110 26
 Columna monomando extensible con kit
 Single lever extensible column with kit

Box: 1 | Carton: 2 | Pallet: 8



R63112 26 DXK3 45 100135 60 00 100053 9908 0033
 9908 0034 9908 0035 100128 45

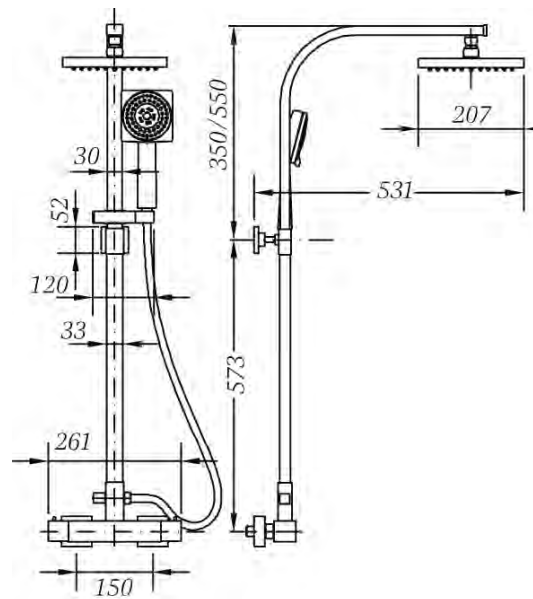

Ref.: CT67110 26
 Columna termostática extensible con kit
 Thermostatic extensible column with kit

Box: 1 | Carton: 2 | Pallet: 8



R63112 26 DXK3 45 100135 60 00 100037 9908 0033
 9908 0034 100069 100128 45

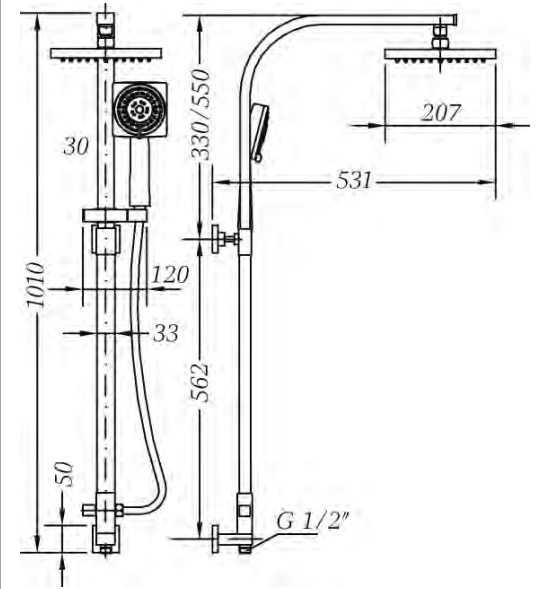

Ref.: 1746 45
 Set columna extensible con ducha, soporte y flexo
 Extensible column set with shower, holder and flexible hose

Box: 1 | Carton: 2 | Pallet: 8



R63112 26 DXK3 45 100135 60 00 9908 0033 9908 0034 9908 0035

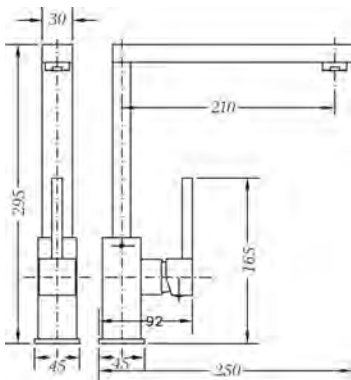

Ref.: FRK63400
 Monomando de fregadera cartucho 25
 Single lever sink mixer cartridge 25

Box: 1 | Carton: 8 | Pallet: 96



100044 100095 100103 100085 45 9908 0045 JFK

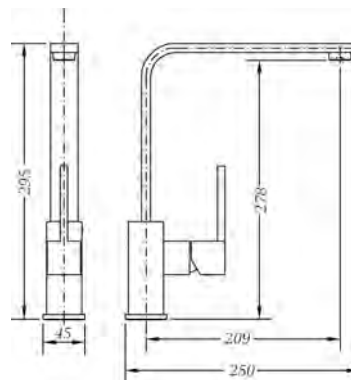

Ref.: FRK63401
 Monomando de fregadera cartucho 25
 Single lever sink mixer cartridge 25

Box: 1 | Carton: 8 | Pallet: 96



100044 100095 100103 100085 45 9908 0045 JFK

serie Inox

Acero inoxidable. Cartucho 35 | *Stainless steel. Cartridge 35*

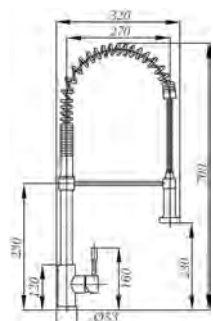

Ref.: 65211 18 60 66

Monomando de fregadera inox con muelle
Stainless steel single-handle with spring

Box: 1 | Carton: 4 | Pallet: 36

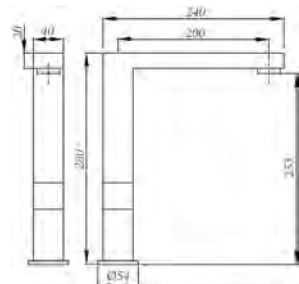

Ref.: 65208 18 60 66

Monomando de fregadera inox doble función Cubik
Stainless steel single-handle square dual function Cubik

Box: 1 | Carton: 4 | Pallet: 72

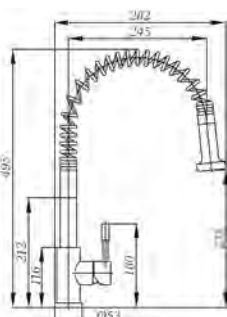

Ref.: 65207 18 60 66

Monomando de fregadera inox con muelle y ducha extraíble
Stainless steel single-handle with spring and pull-out sprayer

Stainless steel single-handle with spring and pull-out sprayer

Box: 1 | Carton: 4 | Pallet: 36

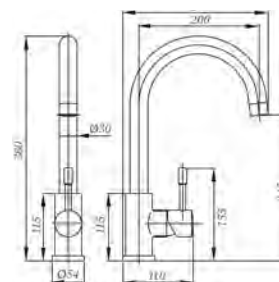

Ref.: 65203 18 60 66

Monomando de fregadera inox caño cisne
Stainless steel single-handle sink tap, swan pipe

Box: 1 | Carton: 5 | Pallet: 90



serie Ge2

Acabado cromado. Cartucho 40 | *Chromed finish. Cartridge 40*

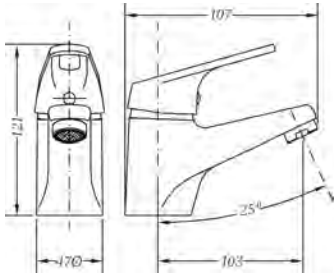

Ref.: 61130 22 45 66
 Monomando de lavabo Plus
Single lever Plus wash-basin mixer

Box: 1 | Carton: 20 | Pallet: 360

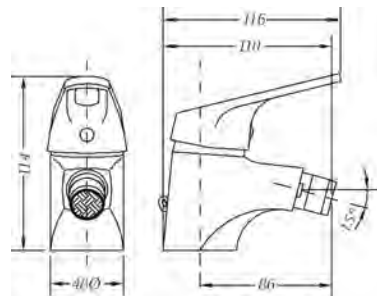

Ref.: 60140 22 45 66
 Monomando de bidé
Single lever bidet mixer

Box: 1 | Carton: 20 | Pallet: 360

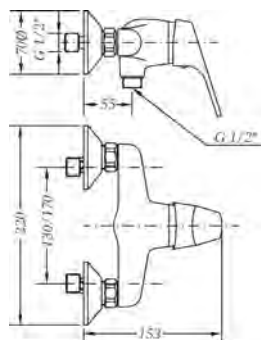

Ref.: 60110 22 45 66
 Monomando de ducha con kit
Single lever shower mixer with kit

Box: 1 | Carton: 8 | Pallet: 128



100125 45

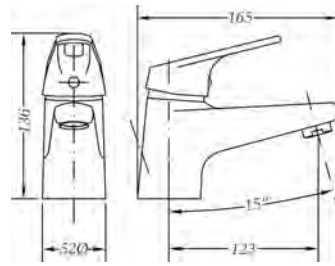

Ref.: 60130 22 45 66
 Monomando de lavabo
Single lever wash-basin mixer

Box: 1 | Carton: 20 | Pallet: 360

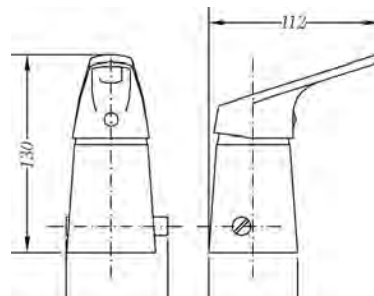

Ref.: 61142 22 45 66
 Monomando de bidé con transmisión
Single lever bidet mixer with diverter

Box: 1 | Carton: 12 | Pallet: 216

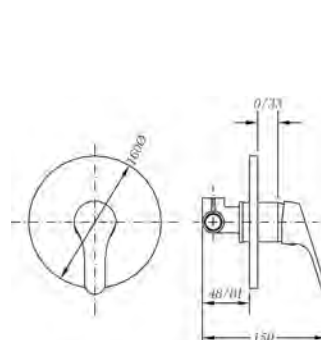

Ref.: 61115 22 45 66
 Monomando de ducha empotrado
Built-in single lever shower

Box: 1 | Carton: 12 | Pallet: 216

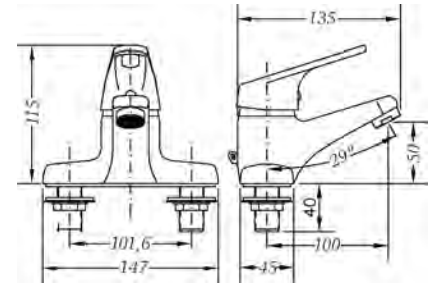

Ref.: 60188 22 45 66
 Monomando de lavabo centerset 4"
Single lever wash-basin mixer 4" centerset

Box: 1 | Carton: 12 | Pallet: 216

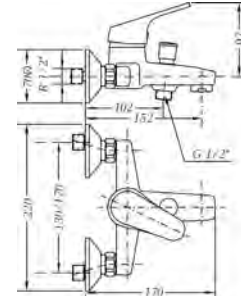
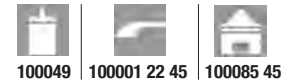

Ref.: 60100 22 45 66
 Monomando de baño con kit
Single lever bath mixer with kit

Box: 1 | Carton: 8 | Pallet: 128

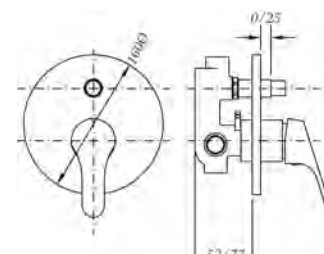

Ref.: 61116 22 45 66
 Monomando de baño empotrado con inversor
Built-in single lever bath with diverter

Box: 1 | Carton: 12 | Pallet: 216



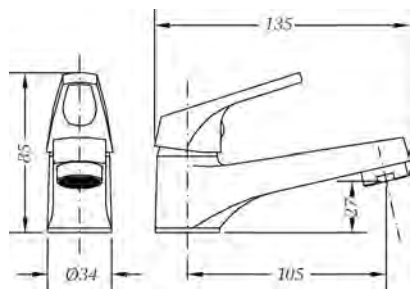

Ref.: 1002 04
Grifo lavabo 1 agua cartucho 25
1 water wash basin 25 cartridge

Box: 1 | Carton: 54 | Pallet: 972



100042 | 100085 45 | 100001 33 45

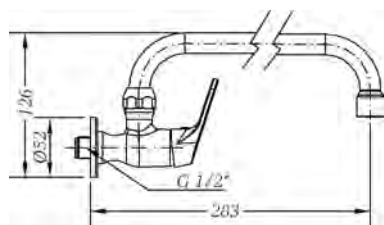

Ref.: 1008 04
Grifo mural con tubo 24 cm 1 agua cartucho 25
1 water wall sink spout 24cm 25 cartridge

Box: 1 | Carton: 27 | Pallet: 486



100042 | 100001 33 45 | 100088 45 | 68902 45 | J68

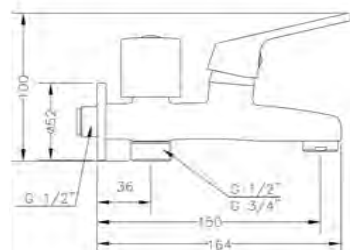

Ref.: 1024 04
Grifo doble combinable a 1/2" - 3/4" y atomizador
Double outlet tap 1/2" - 3/4" and aerator

Box: 1



100042 | 100085 45 | 100001 33 45 | 68995 45 | 68998 28 45

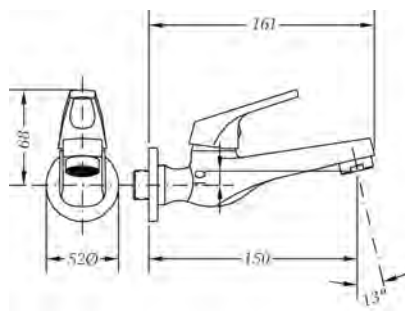

Ref.: 1003 04
Grifo lavabo mural 1 agua cartucho 25
1 water wall wash basin 25 cartridge

Box: 1 | Carton: 48 | Pallet: 864



100042 | 100001 33 45 | 100085 45

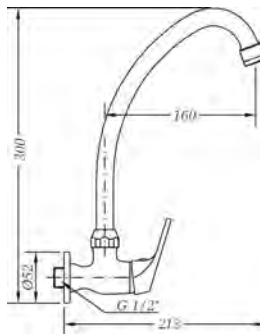

Ref.: 1005 04
Grifo mural con tubo alto 1 agua cartucho 25
1 water wall sink high spout 25 cartridge

Box: 1 | Carton: 27 | Pallet: 486



100042 | 100088 45 | 100001 33 45 | 68903 45 | J68

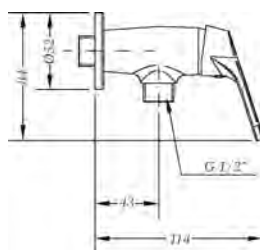

Ref.: 60001 22 45 67
Grifo bide mural 1 agua cartucho 25
1 water wall bidet 25 cartridge

Box: 1 | Carton: 54 | Pallet: 972



100042 | 100001 33 45

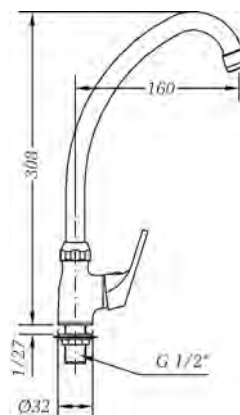

Ref.: 1009 04
Grifo fregadera 1 agua cartucho 25
1 water sink 25 cartridge

Box: 1 | Carton: 27 | Pallet: 486



100042 | 100088 45 | 100001 33 45 | 68903 45 | J68

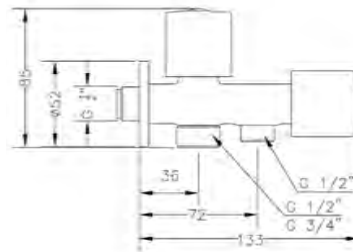

Ref.: 1023 04
Grifo doble combinable 1/2"-3/4" y 1/2"
Double outlet tap 1/2" - 3/4" and 1/2"

Box: 1



68998 28 45 | 68995 45

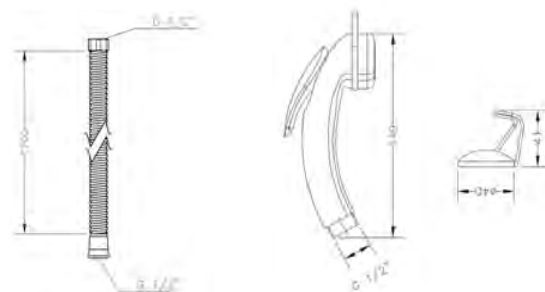

Ref.: 100141
Flexo 1,20m. inoxidable
Stainless steel flexible hose 1,20 m.

Box: 1 | Carton: 50 | Pallet: 900

Ref.: 100696 45
Kit soporte y teleducha bidé
Holder and bidet gorage

Box: 1 | Carton: 100 | Pallet: 1800

serie Sigma

Acabado cromado. Cartucho 40 | Chromed finish. Cartridge 40

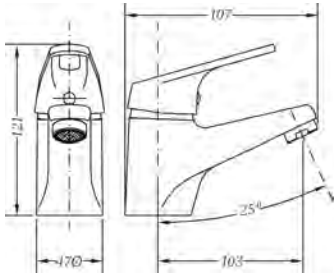

Ref.: 61130 06 45 66
Monomando de lavabo Plus
Single lever Plus wash-basin mixer

Box: 1 | Carton: 20 | Pallet: 360



100049 100103 100085 45 100001 06 45 100092

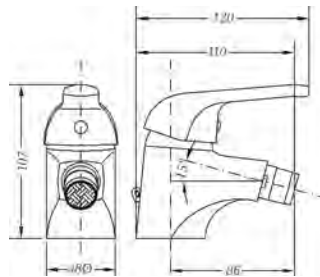

Ref.: 60140 06 45 66
Monomando de bidé
Single lever bidet mixer

Box: 1 | Carton: 20 | Pallet: 360



100049 100103 100001 06 45 100086 45 100092

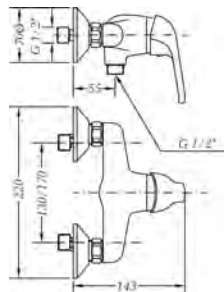

Ref.: 60110 06 45 66
Monomando de ducha con kit
Single lever shower mixer with kit

Box: 1 | Carton: 8 | Pallet: 128



100049 100175 45 00 100152 45 00 100001 06 45 100135 60 00



100125 45

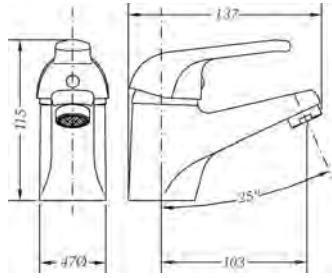

Ref.: 60130 06 45 66
Monomando de lavabo
Single lever wash-basin mixer

Box: 1 | Carton: 20 | Pallet: 360



100049 100103 100085 45 100001 06 45 100092

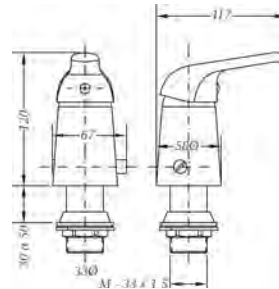

Ref.: 61142 06 45 66
Monomando de bidé con transmisión
Single lever bidet mixer with diverter

Box: 1 | Carton: 12 | Pallet: 216



100051 100107 100019 100001 06 45

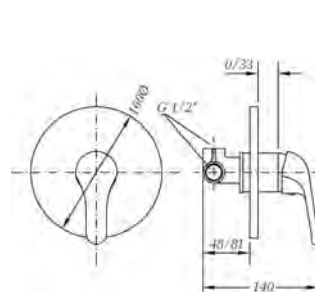

Ref.: 61115 06 45 66
Monomando de ducha empotrado
Built-in single lever shower

Box: 1 | Carton: 12 | Pallet: 216

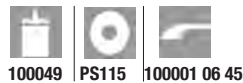

100049 PS115 100001 06 45

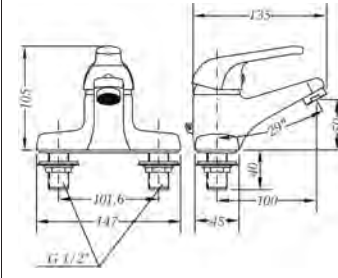

Ref.: 60188 06 45 66
Monomando de lavabo centerset 4"
Single lever wash-basin mixer 4" centerset

Box: 1 | Carton: 12 | Pallet: 216

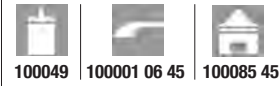

100049 100001 06 45 100085 45

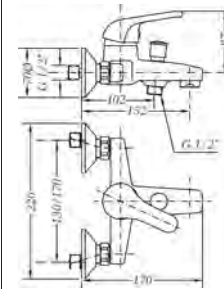

Ref.: 60100 06 45 66
Monomando de baño con kit
Single lever bath mixer with kit

Box: 1 | Carton: 8 | Pallet: 128



100049 100175 45 00 100152 45 00 100001 06 45 100135 60 00



100083 45 100160 45 100125 45

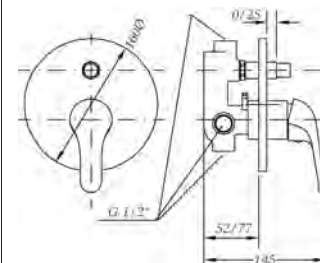

Ref.: 61116 06 45 66
Monomando de baño empotrado con inversor
Built-in single lever bath with diverter

Box: 1 | Carton: 12 | Pallet: 216



100049 100162 45 100001 06 45 PS116

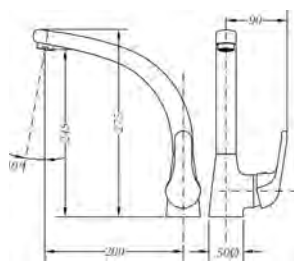

Ref.: 61201 06 45 66
 Monomando de fregadera caño fundido
Single lever sink mixer casted spout

Box: 1 | Carton: 6 | Pallet: 108

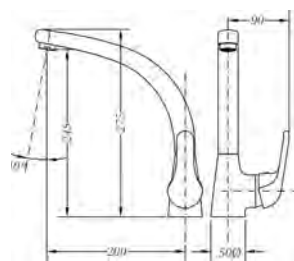
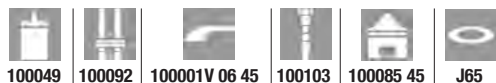

Ref.: 61203 06 45 66
 Monomando de fregadera caño conformado
Single-lever sink mixer tube spout

Box: 1 | Carton: 6 | Pallet: 108

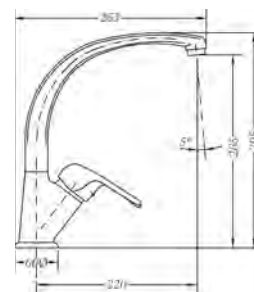
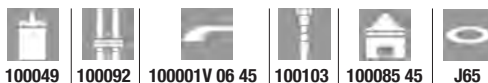

Ref.: 61204 06 45 66
 Monomando de fregadera caño conformado
Single-lever sink mixer tube spout

Box: 1 | Carton: 6 | Pallet: 108

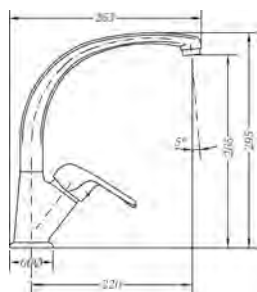

Ref.: 61210 06 45 66
 Monomando de fregadera caño fundido
Single lever sink mixer casted spout

Box: 1 | Carton: 6 | Pallet: 108

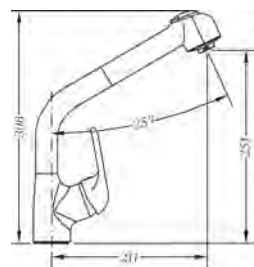
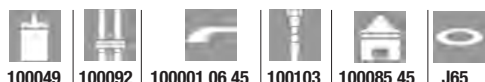

Ref.: 61206 06 45 66
 Monomando de fregadera ducha extraíble
Single-lever sink mixer with pull-out spray

Box: 1 | Carton: 10 | Pallet: 108

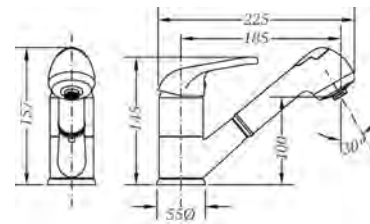
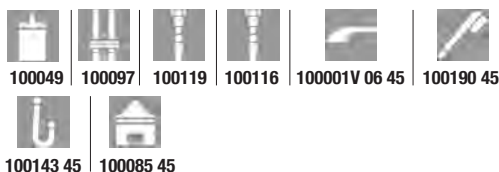

Ref.: 61205 06 45 66
 Monomando de fregadera ducha extraíble
Single lever sink mixer with pull-out spray

Box: 1 | Carton: 9 | Pallet: 162

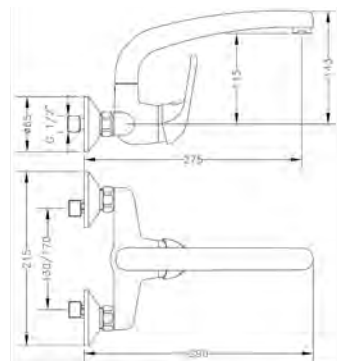

Ref.: 61192 06 45 66
 Monomando de fregadera mural 15 cm
Single-lever wall sink mixer 15 cm

Box: 1 | Carton: 6 | Pallet: 72

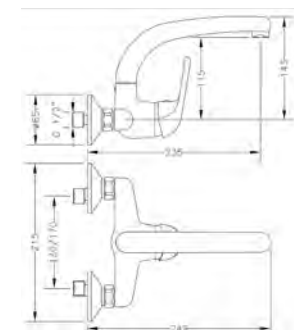

Ref.: 61190 06 45 66
 Monomando de fregadera mural 15 cm caño corto
Wall single lever sink mixer 15cm short spout

Box: 1 | Carton: 6 | Pallet: 108

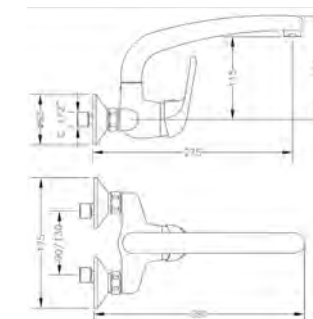

Ref.: 61195 06 45 66
 Monomando de fregadera mural 11 cm
Wall single lever sink mixer 11 cm

Box: 1 | Carton: 9 | Pallet: 162



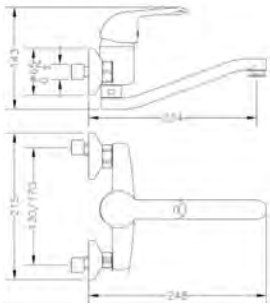

Ref.: 61196 06 45 66
 Monomando de fregadera caño inferior elevado
 Wall single lever sink mixer low spout

Box: 1 | Carton: 8 | Pallet: 192



100051 | 100125 45 | 100001V 06 45 | 100085 45 | J65

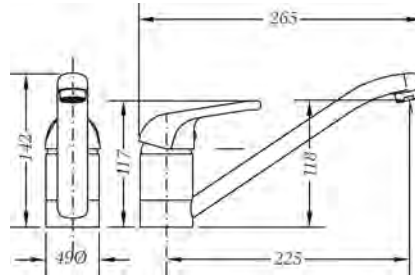

Ref.: 61200 06 45 66
 Monomando de fregadera
 Single lever sink mixer

Box: 1 | Carton: 9 | Pallet: 288

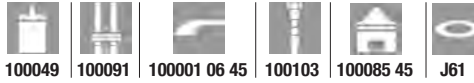

100049 | 100091 | 100001 06 45 | 100103 | 100085 45 | J61

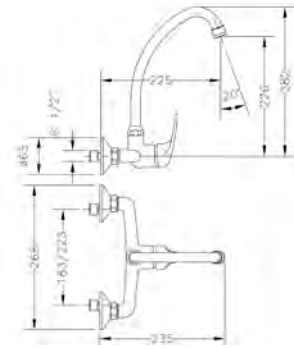

Ref.: 60194 05 45 66
 Monomando de fregadera mural 8"
 Wall single lever 8" sink mixer

Box: 1

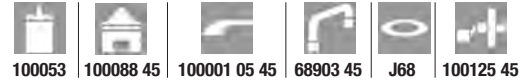

100053 | 100088 45 | 100001 05 45 | 68903 45 | J68 | 100125 45

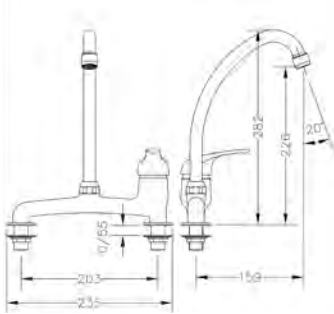

Ref.: 60198 05 45 66
 Monomando mesada 8"
 8" wide spread single lever sink mixer

Box: 1



100053 | 100088 45 | 100001 05 45 | 68903 45 | J68

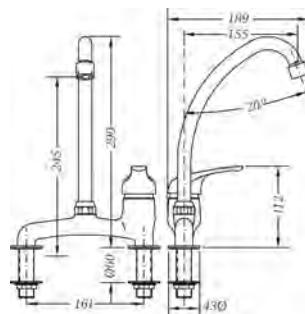

Ref.: 60199 05 45 66
 Monomando mesada 6"
 6" wide spread single lever sink mixer

Box: 1 | Carton: 10 | Pallet: 240



100053 | 100088 45 | 68903 45 | 100001 05 45 | J68

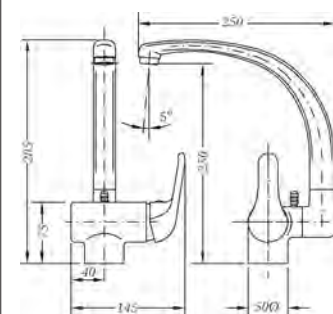

Ref.: 61900 06 45 66
 Monomando de fregadera abatible
 Single lever folding sink mixer

Box: 1 | Carton: 8 | Pallet: 128

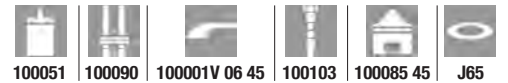

100051 | 100090 | 100001V 06 45 | 100103 | 100085 45 | J65

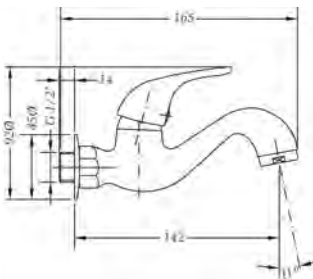

Ref.: 1006 04
 Grifo lavabo mural 1 agua cartucho 25
 1 water wall wash basin cartridge 25

Box: 1 | Carton: 36 | Pallet: 864



100042 | 100085 45

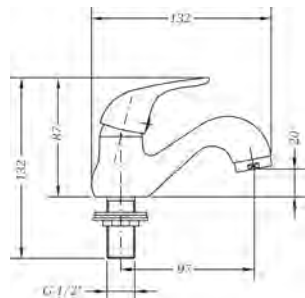

Ref.: 1007 04
 Grifo lavabo 1 agua cartucho 25
 1 water wash basin cartridge 25

Box: 1 | Carton: 32 | Pallet: 768



100042 | 100085 45

serie New Regent Classic

Montura 1/4 vuelta cierre cerámico | Ceramic headwork quarter turn

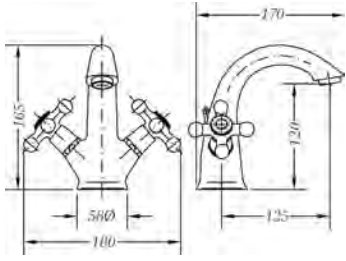

Ref.: 68506 09 45 66
Monobloc de lavabo cromo
Wash basin mixer chromed

Box: 1 | Carton: 8 | Pallet: 144

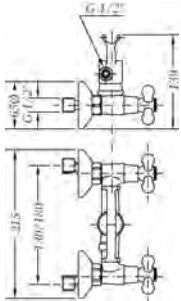

Ref.: 68531 09 45 66
Mezclador de ducha cromo con kit
Shower mixer chromed with kit

Box: 1 | Carton: 8 | Pallet: 96

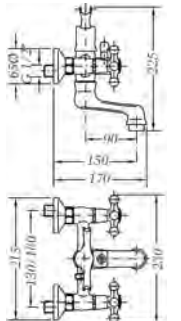

Ref.: 68526 09 43 66
Mezclador de baño bronce con kit
Bath mixer bronze with kit

Box: 1 | Carton: 4 | Pallet: 72

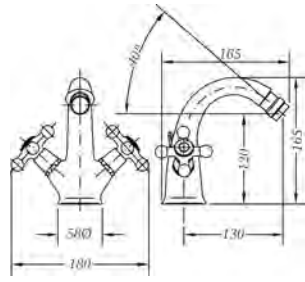

Ref.: 68516 09 45 66
Monobloc de bidé cromo
Bidet mixer chromed

Box: 1 | Carton: 8 | Pallet: 144

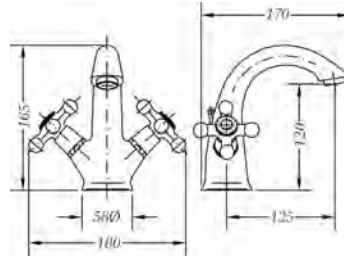

Ref.: 68506 09 43 66
Monobloc de lavabo bronce
Wash basin mixer bronze

Box: 1 | Carton: 8 | Pallet: 144

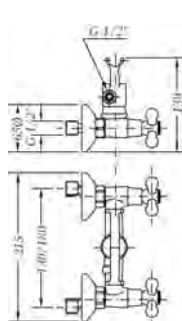

Ref.: 68531 09 43 66
Mezclador de ducha bronce con kit
Shower mixer bronze with kit

Box: 1 | Carton: 8 | Pallet: 96

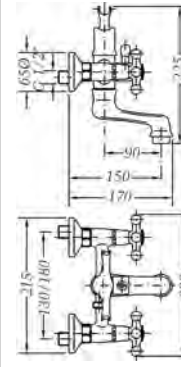

Ref.: 68526 09 45 66
Mezclador de baño cromo con kit
Bath mixer chromed with kit

Box: 1 | Carton: 4 | Pallet: 72

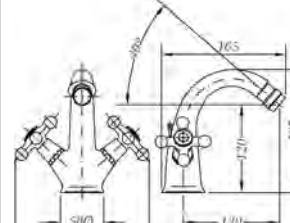

Ref.: 68516 09 43 66
Monobloc bidet bronce
Bidet mixer bronze

Box: 1 | Carton: 8 | Pallet: 144

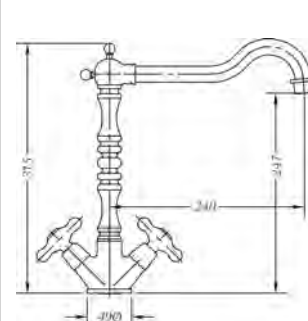

Ref.: 68595 09 45 66
Monobloc de fregadera cromo
Sink mixer chromed

Box: 1 | Carton: 4 | Pallet: 72



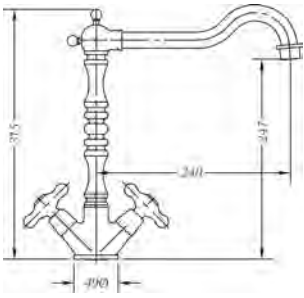

Ref.: 68595 09 43 66
 Monobloc de fregadera bronce
 Sink mixer bronze

Box: 1 | Carton: 4 | Pallet: 72



68995 09 | 100090 | 100103 | 68998 09 43 | 100069 43 | J65

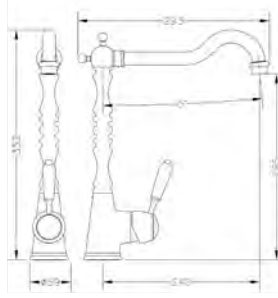

Ref.: 68201 39 45 66
 Monomando de fregadera cromo cartucho 40
 Sink mixer chromed 40 cartridge

Box: 1 | Carton: 4 | Pallet: 72



100049 | 100103 | 100069 45 | 100092 | 100001 39 45 | J65

serie New Regent

Acabado cromado. Montura 1/4 vuelta cierre cerámico | Chromed finish. Ceramic headwork quarter turn.

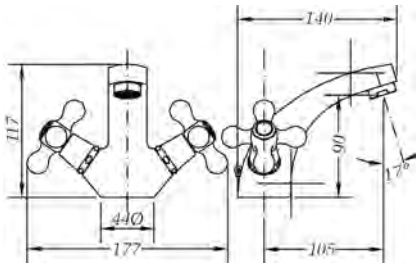

Ref.: 68505 09 45 66
 Monobloc de lavabo
 Wash basin mixer

Box: 1 | Carton: 12 | Pallet: 216

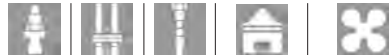

68995 09 | 100090 | 100103 | 100085 45 | 68998 09 45

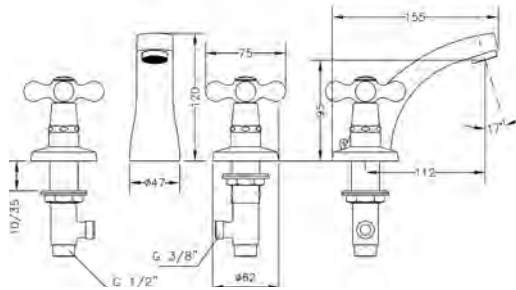

Ref.: 68510 09 45 66
 Batería lavabo
 Widespread wash basin mixer

Box: 1 | Carton: 10 | Pallet: 240



68995 09 | 100107 | 100090 | 100085 45 | 68998 09 45

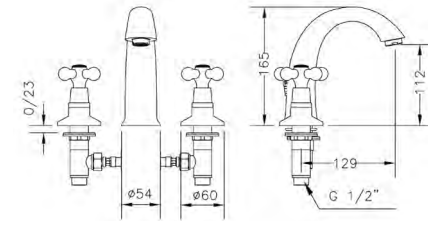

Ref.: 68120 09 45 66
 Batería lavabo
 Widespread wash basin mixer

Box: 1 | Carton: 6 | Pallet: 240



68995 09 | 100107 | 100085 45 | 68998 09 45

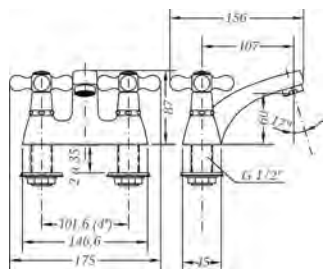

Ref.: 68511 09 45 66
 Mezclador lavabo centerset 4"
 Wash-basin mixer 4" centerset

Box: 1 | Carton: 12 | Pallet: 216



68995 09 | 68998 09 45 | 100085 45

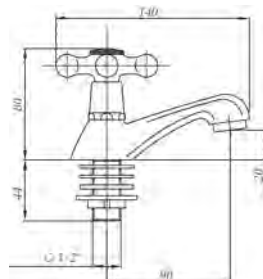

Ref.: 68500 09 45 66
 Grifo lavabo
 Wash basin tap

Box: 1 | Carton: 24 | Pallet: 240



68995 09 | 100085 45 | 68998 09 45

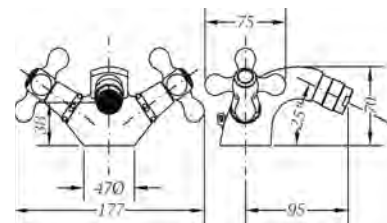

Ref.: 68515 09 45 66
 Monobloc de bidé
 Bidet mixer

Box: 1 | Carton: 12 | Pallet: 216



68995 09 | 100090 | 100086 45 | 100103 | 68998 09 45

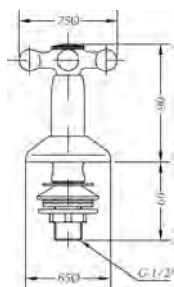

Ref.: 68520 09 45 66
Grifo bidé
Bidet tap

Box: 1 | Carton: 24 | Pallet: 576



68995 09 | 68998 09 45

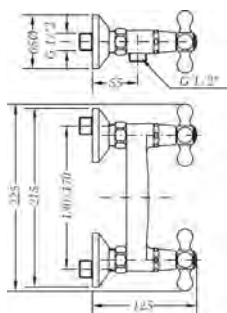

Ref.: 68530 09 45 66
Mezclador de ducha con kit
Shower mixer with kit

Box: 1 | Carton: 12 | Pallet: 216



68995 09 | 10075 45 00 | 100152 45 | 100135 60 00 | 100125 45



68998 09 45

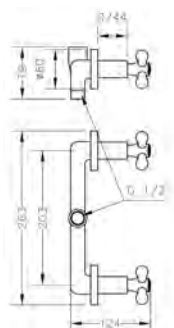

Ref.: 68535 09 45 66
Grupo ducha empotrado 8"
Built-in 8" shower mixer

Box: 1 | Carton: 10 | Pallet: 240



67895 45 | 68998 09 45

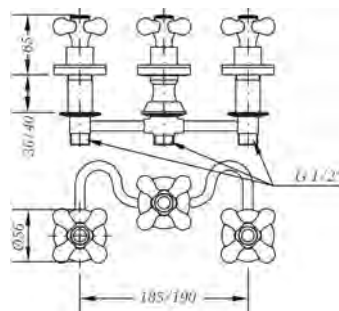

Ref.: 68142 09 45 66
Batería de bidé con transmisión
Widespread bidet mixed with transmission

Box: 1 | Carton: 10 | Pallet: 240



67895 45 | 100174 45 | 68998 09 45

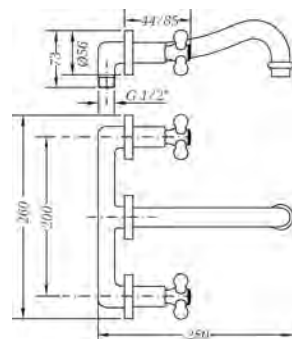

Ref.: 68131 09 45 66
Grupo de lavabo empotrado
Built-in wash basin

Box: 1 | Carton: 10 | Pallet: 240



67895 45 | 68998 09 45 | 68914 45 | 100069 45

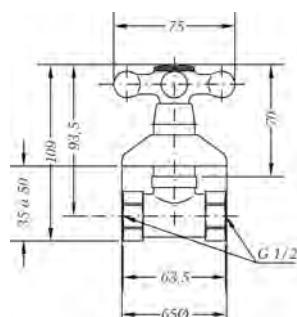

Ref.: 68590 09 45 66
Llave de paso 1/2"
Stopcock 1/2"

Box: 1 | Carton: 24 | Pallet: 240



67895 45 | 68998 09 45

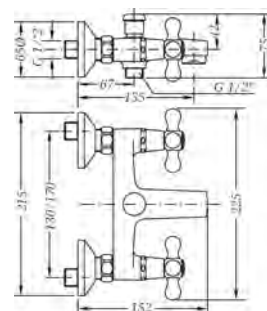

Ref.: 68525 09 45 66
Mezclador de baño con kit
Bath mixer with kit

Box: 1 | Carton: 12 | Pallet: 216



68995 09 | 100160 45 | 68998 09 45 | 100125 45 | 10075 45 00



100152 45 | 100083 | 100135 60 00

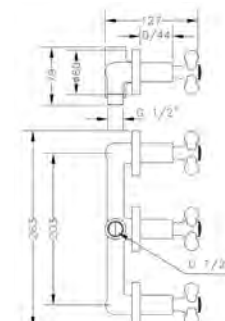

Ref.: 68527 09 45 66
Grupo baño empotrado 8" con inversor
Built-in 8" bath mixer with diverter

Box: 1 | Carton: 10 | Pallet: 240



67895 45 | 100173 45 | 68998 09 45

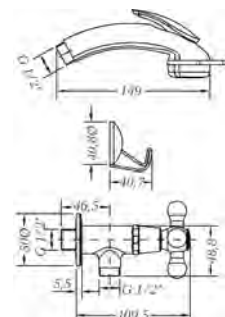

Ref.: 68001 09 45 66
Grifo de bide con teleducha
Bidet tap with shower

Box: 1 | Carton: 20 | Pallet: 360



68995 09 | 100141 45 | 100696 45 | 68998 09 45

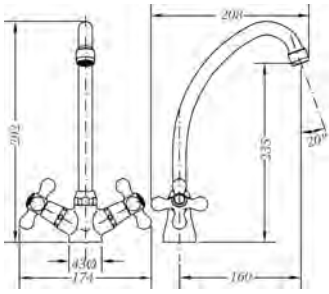

Ref.: 68540 09 45 66
 Monobloc fregadera caño tubo
 Sink mixer goose neck spout

Box: 1 | Carton: 10 | Pallet: 240



68995 09 68903 45 100088 45 100090 100103



68998 09 45 J68

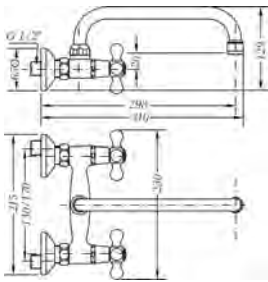

Ref.: 68555 09 45 66
 Grupo mural fregadera 15 cm caño tubo alto 24cm
 Wall mounted sink mixer 15 cm with high tube spout 24cm

Box: 1 | Carton: 10 | Pallet: 240



68995 09 68902 45 100088 45 68998 09 45 100125 45 J68

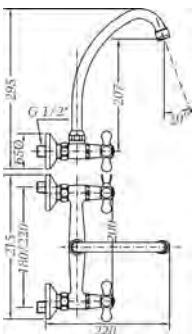

Ref.: 68570 09 45 66
 Grupo mural fregadera 20 cm caño tubo alto vertical
 Wall sink mixer 20cm swan neck spout

Box: 1 | Carton: 10 | Pallet: 240



68995 09 68903 45 100088 45 68998 09 45 100125 45 J68

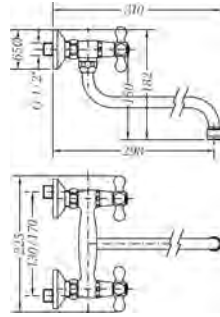

Ref.: 68550 09 45 66
 Grupo mural fregadera 11 cm caño tubo alto 18cm
 Wall sink mixer 11cm high tube spout 18cm

Box: 1 | Carton: 10 | Pallet: 240



68995 09 68901 45 100088 45 68998 09 45 100125 45 J68

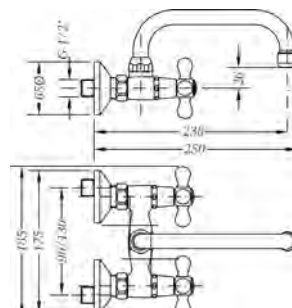

Ref.: 68560 09 45 66
 Grupo mural fregadera 15cm caño tubo bajo 24cm
 Wall sink mixer 15cm low tube spout 24cm

Box: 1 | Carton: 10 | Pallet: 240



68995 09 68904 45 100088 45 68998 09 45 100125 45 J68

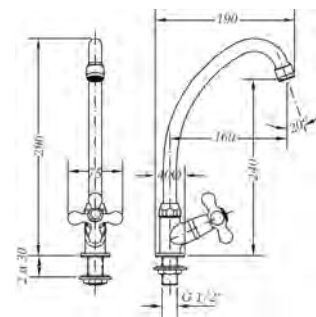

Ref.: 68585 09 45 66
 Grifo fregadera vertical caño tubo
 Sink tap with tube spout

Box: 1 | Carton: 10 | Pallet: 240



68995 09 68903 45 100088 45 68998 09 45 J68

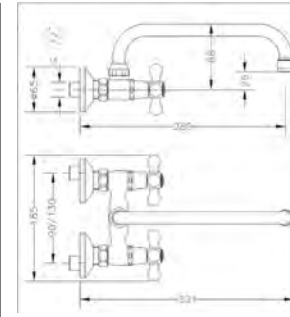

Ref.: 68196 09 45 66
 Grupo mural fregadera 11 cm caño tubo alto 24cm
 Wall sink mixer 11cm high tube spout 24cm

Box: 1 | Carton: 10 | Pallet: 240



68995 09 68902 45 100088 45 68998 09 45 100125 45 J68

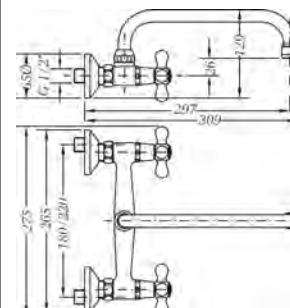

Ref.: 68565 09 45 66
 Grupo mural fregadera 20 cm caño tubo alto 24cm
 Wall sink mixer 20cm high tube spout 24cm

Box: 1 | Carton: 10 | Pallet: 240



68995 09 68902 45 100088 45 68998 09 45 100125 45 J68

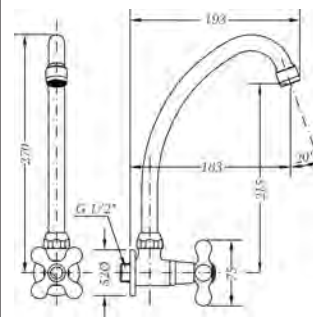

Ref.: 68575 09 45 66
 Grifo fregadera mural caño tubo vertical
 Wall sink tap with goose neck spout

Box: 1 | Carton: 10 | Pallet: 240



68995 09 68903 45 68998 09 45 100088 45 J68

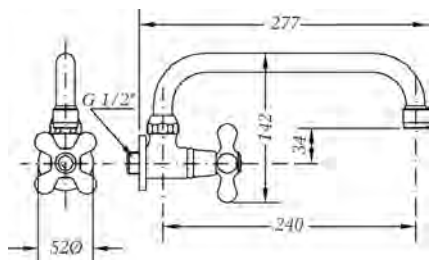

Ref.: 68580 09 45 66
Grifo mural fregadera caño tubo alto 24cm
Wall sink tap with tube spout 24cm

Box: 1 | Carton: 10 | Pallet: 240



68995 09 | 68902 45 | 68998 09 45 | 100088 45 | J68

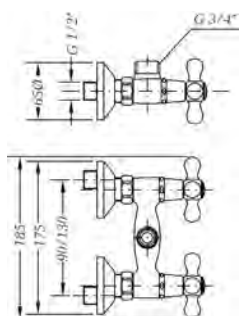

Ref.: 568550 45
Cuerpo grupo mural 11 cm
Wall mixer 11 cm

Box: 1 | Carton: 15 | Pallet: 360



68995 09 | 100125 45 | 68998 09 45

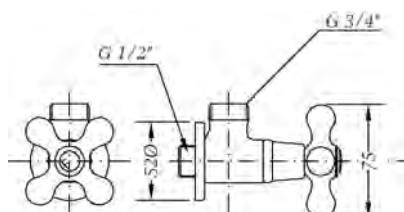

Ref.: 568575 45
Cuerpo grifo mural
Wall tap

Box: 1 | Carton: 30 | Pallet: 540



68995 09 | 68998 09 45

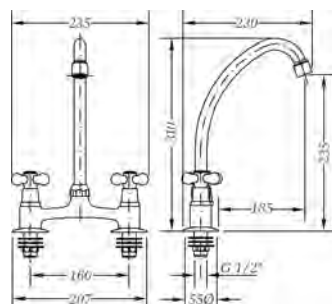

Ref.: 68194 09 45 66
Mezclador mesada 6" caño tubo
Mixer mesada 6" swan neck spout

Box: 1 | Carton: 10 | Pallet: 240



68995 09 | 68903 45 | 68998 09 45 | 100088 45 | J68

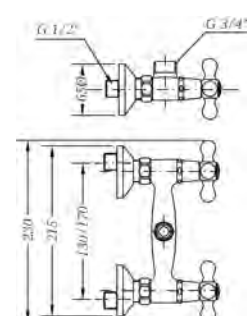

Ref.: 568555 45
Cuerpo grupo mural 15cm
Wall mixer 15 cm

Box: 1 | Carton: 15 | Pallet: 360



68995 09 | 100125 45 | 68998 09 45

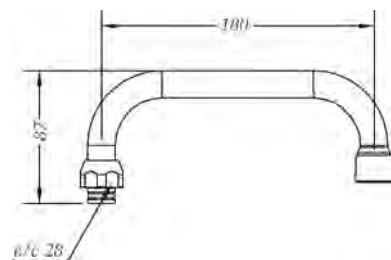

Ref.: 68901 45
Caño alto tubo 18 cm
High tube spout 18 cm

Box: 1 | Carton: 40 | Pallet: 720



100088 45 | J68

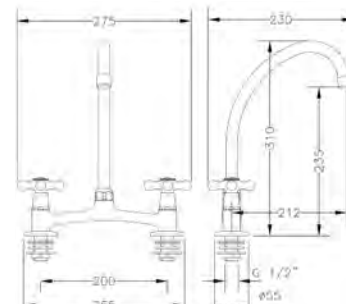

Ref.: 68545 09 45 66
Mezclador mesada 8" caño tubo
Mixer mesada 8" swan neck spout

Box: 1 | Carton: 10 | Pallet: 240



68995 09 | 68903 45 | 68998 09 45 | 100088 45 | J68

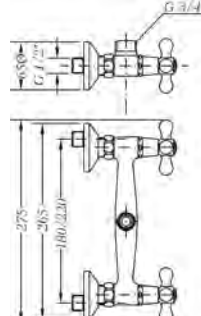

Ref.: 568565 45
Cuerpo grupo mural 20cm
Wall mixer 20 cm

Box: 1 | Carton: 15 | Pallet: 360



68995 09 | 68998 09 45 | 100125 45

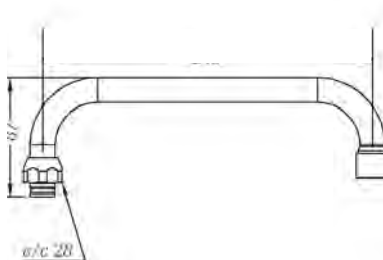

Ref.: 68902 45
Caño alto tubo 24 cm
High tube spout 24 cm

Box: 1 | Carton: 30 | Pallet: 540



100088 45 | J68

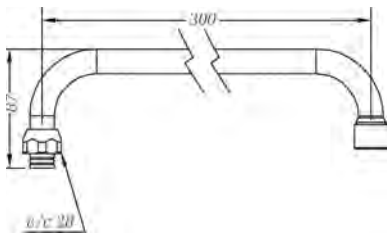

Ref.: 68908 45
Caño alto tubo 30 cm
High tube spout 30 cm

Box: 1 | Carton: 40 | Pallet: 720



100088 45 | J68

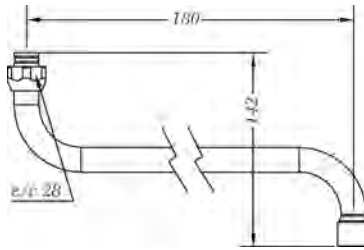

Ref.: 68910 45
Caño bajo tubo 18 cm
Low tube spout 18 cm

Box: 1 | Carton: 40 | Pallet: 720



100088 45 | J68

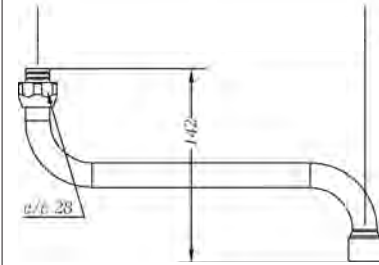

Ref.: 68904 45
Caño bajo tubo 24 cm
Low tube spout 24 cm

Box: 1 | Carton: 30 | Pallet: 540



100088 45 | J68

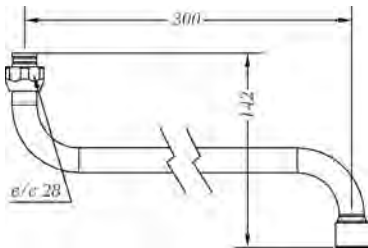

Ref.: 68909 45
Caño bajo tubo 30 cm
Low tube spout 30 cm

Box: 1 | Carton: 40 | Pallet: 720



100088 45 | J68

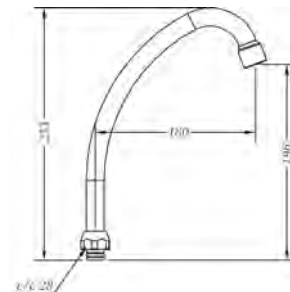

Ref.: 68903 45
Caño tubo vertical
Swan neck spout

Box: 1 | Carton: 30 | Pallet: 540



100088 45 | J68

serie Gamma

Acabado cromado. Montura convencional | Chromed finish. Conventional headwork.

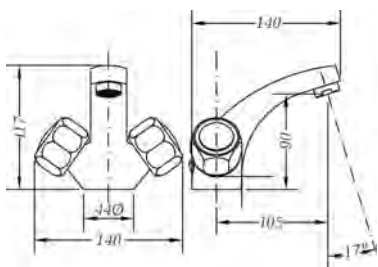

Ref.: 68130 11 45 66
Monobloc de lavabo
Wash basin mixer

Box: 1 | Carton: 12 | Pallet: 216



68995 11 | 100090 | 100103 | 68998 11 45 | 100085 45

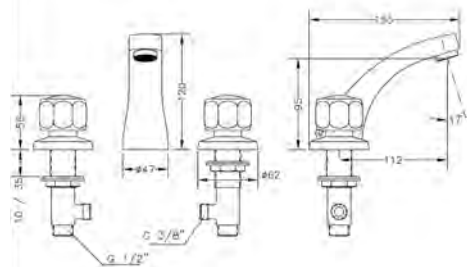

Ref.: 68120 11 45 66
Batería de lavabo
Widespread wash basin mixer

Box: 1 | Carton: 10 | Pallet: 240



68995 11 | 100107 | 100085 45 | 68998 11 45

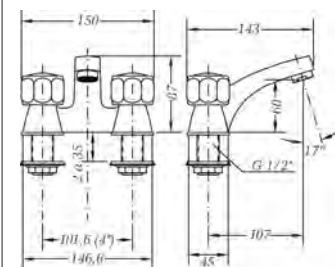

Ref.: 68122 11 45 66
Mezclador lavabo centerset 4"
Wash-basin mixer 4" centerset

Box: 1 | Carton: 12 | Pallet: 216



68995 11 | 100085 45 | 68998 11 45

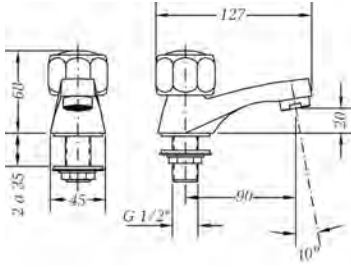

Ref.: 68180 11 45 66
Grifo de lavabo
Wash basin tap

Box: 1 | Carton: 24 | Pallet: 576



68995 11 | 100085 45 | 68998 11 45

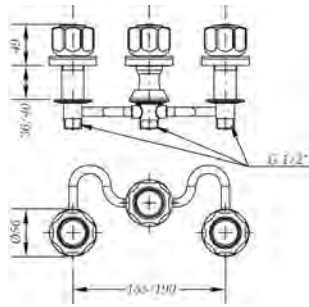

Ref.: 68142 11 45 66
Batería de bidé con transmisión
Widespread bidet mixer with transmission

Box: 1 | Carton: 10 | Pallet: 240



68995 11 | 100174 45 | 68998 11 45

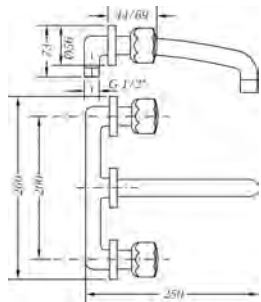

Ref.: 68131 11 45 66
Grupo de lavabo empotrado
Built-in wash basin

Box: 1 | Carton: 10 | Pallet: 240



67896 45 | 68998 11 45 | 68917 45 | 100088 45

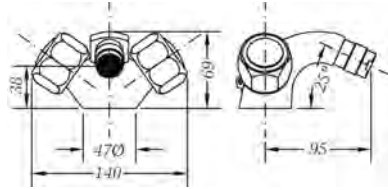

Ref.: 68140 11 45 66
Monobloc de bidé
Bidet mixer

Box: 1 | Carton: 12 | Pallet: 216



68995 11 | 100090 | 100086 45 | 100103 | 68998 11 45

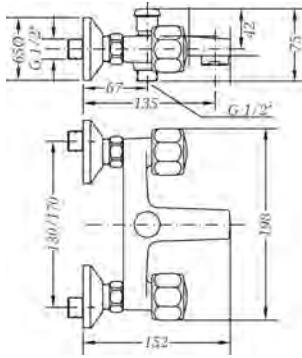

Ref.: 68100 11 45 66
Mezclador de baño con kit
Bath mixer with kit

Box: 1 | Carton: 12 | Pallet: 216



68995 11 | 100175 45 00 | 100152 45 00 | 100135 60 00 | 100083 45



100125 45 | 100160 45 | 68998 11 45

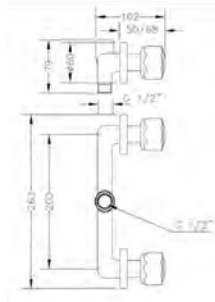

Ref.: 68115 11 45 66
Grupo ducha empotrado 8"
Built-in 8" shower mixer

Box: 1 | Carton: 10 | Pallet: 240



67896 45 | 68998 11 45

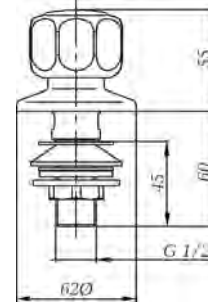

Ref.: 68160 11 45 66
Grifo bidé
Bidet tap

Box: 1 | Carton: 24 | Pallet: 576



68995 11 | 68998 11 45

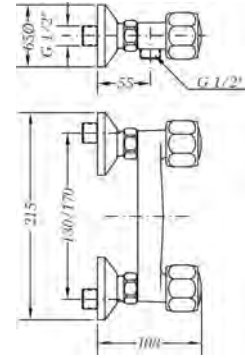

Ref.: 68110 11 45 66
Mezclador de ducha con kit
Shower mixer with kit

Box: 1 | Carton: 12 | Pallet: 216



68995 11 | 100175 45 00 | 100152 45 00 | 100135 60 00 | 100125 45



68998 11 45

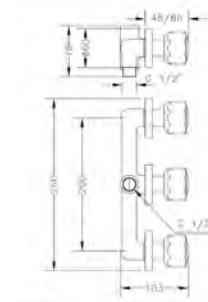

Ref.: 68116 11 45 66
Grupo baño empotrado 8" con inversor
Built-in 8" bath mixer with diverter

Box: 1 | Carton: 10 | Pallet: 240



67896 45 | 100173 45 | 68998 11 45

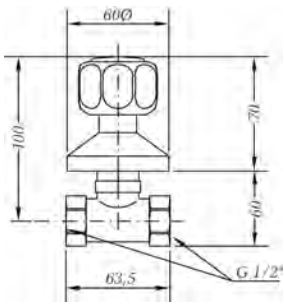

Ref.: 68170 11 45 66
Llave de paso 1/2"
Stopcock 1/2"

Box: 1 | Carton: 24 | Pallet: 576



67896 45 68998 11 45

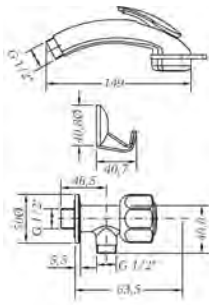

Ref.: 68001 11 45 66
Grifo de bide con teleducha
Bidet tap with shower

Box: 1 | Carton: 20 | Pallet: 360



68995 11 100141 45 100696 45 68998 11 45

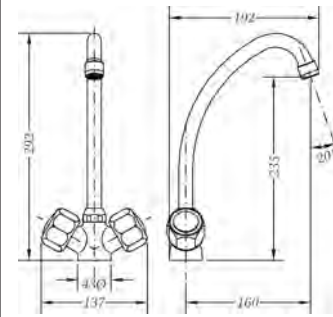

Ref.: 68200 11 45 66
Monobloc de fregadera caño tubo
Sink mixer swan neck spout

Box: 1 | Carton: 10 | Pallet: 240



68995 11 68903 45 100088 45 100090 100103 68998 11 45

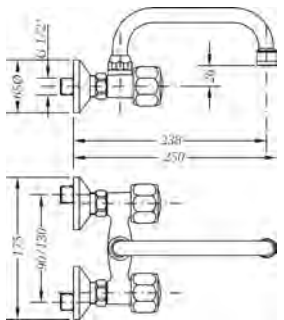

Ref.: 68195 11 45 66
Grupo mural fregadera 11 cm caño tubo alto 18cm
Wall sink mixer 11 cm with high tube spout 18cm

Box: 1 | Carton: 10 | Pallet: 240



68995 11 68901 45 100088 45 100125 45 68998 11 45 J68

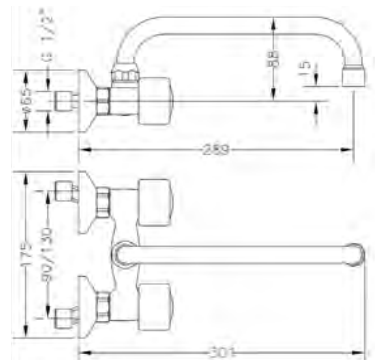

Ref.: 68196 11 45 66
Grupo mural fregadera 11 cm caño tubo alto 24cm
Wall sink mixer 11 cm with high tube spout 24cm

Box: 1 | Carton: 10 | Pallet: 240



68995 11 68902 45 100088 45 100125 45 68998 11 45 J68

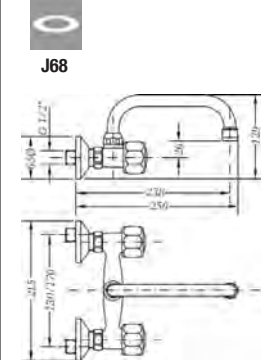

Ref.: 68190 11 45 66
Grupo mural fregadera 15 cm caño tubo alto 18 cm
Wall sink mixer 15 cm with high tube spout 18 cm

Box: 1 | Carton: 10 | Pallet: 240



68995 11 68901 45 100088 45 100125 45 68998 11 45 J68

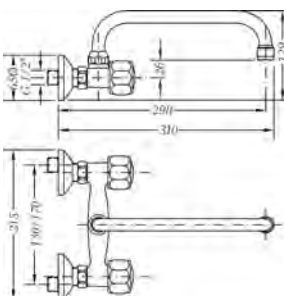

Ref.: 68193 11 45 66
Grupo mural fregadera 15 cm caño tubo alto 24cm
Wall sink mixer 15 cm with high tube spout 24 cm

Box: 1 | Carton: 10 | Pallet: 240



68995 11 68902 45 100088 45 100125 45 68998 11 45 J68

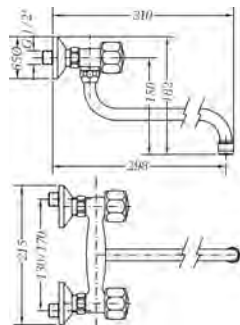

Ref.: 68197 11 45 66
Grupo mural fregadera 15cm caño tubo bajo 24cm
Wall sink mixer 15cm low tube spout 24cm

Box: 1 | Carton: 10 | Pallet: 240



68995 11 68904 45 100088 45 100125 45 68998 11 45 J68

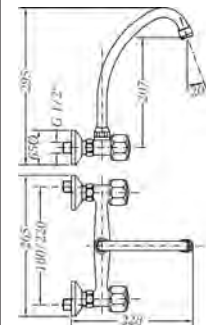

Ref.: 68103 11 45 66
Grupo mural fregadera 20 cm caño tubo alto vertical
Wall sink mixer 20cm swan neck spout

Box: 1 | Carton: 10 | Pallet: 240



68995 11 68903 45 100088 45 100125 45 68998 11 45 J68

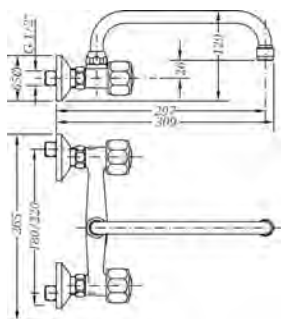

Ref.: 68104 11 45 66
 Grupo mural fregadera 20 cm caño tubo alto 24cm
 Wall sink mixer 20cm high tube spout 24cm

Box: 1 | Carton: 10 | Pallet: 240



68995 11 68902 45 100088 45 100125 45 68998 11 45 J68

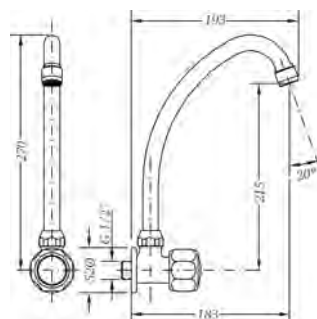

Ref.: 68083 11 45 66
 Grifo fregadera mural caño tubo vertical
 Wall sink tap with swan neck spout

Box: 1 | Carton: 10 | Pallet: 240



68995 11 68903 45 100088 45 68998 11 45 J68

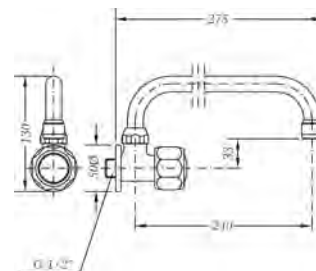

Ref.: 68093 11 45 66
 Grifo mural fregadera caño tubo alto 24cm
 Wall sink tap with tube spout 24cm

Box: 1 | Carton: 10 | Pallet: 240



68995 11 68902 45 100088 45 68998 11 45 J68

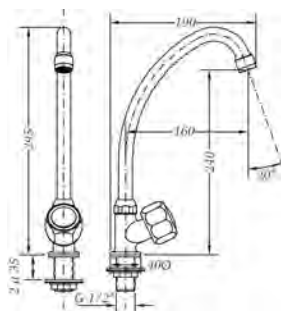

Ref.: 68003 11 45 66
 Grifo fregadera caño tubo vertical
 Sink tap with vertical swan neck spout

Box: 1 | Carton: 10 | Pallet: 240



68995 11 68903 45 100088 45 68998 11 45 J68

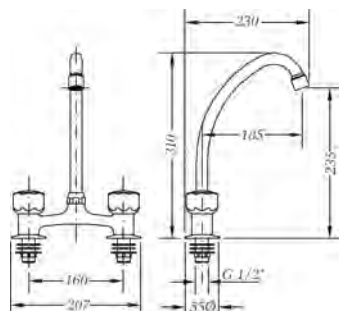

Ref.: 68194 11 45 66
 Mezclador mesada 6" caño tubo
 Mixer mesada 6" swan neck spout

Box: 1 | Carton: 10 | Pallet: 240



68995 11 68903 45 100088 45 68998 11 45 J68

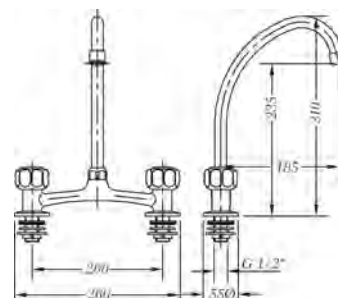

Ref.: 68199 11 45 66
 Mezclador mesada 8" caño tubo
 Mixer mesada 8" swan neck spout

Box: 1 | Carton: 10 | Pallet: 240



68995 11 68903 45 100088 45 68998 11 45 J68

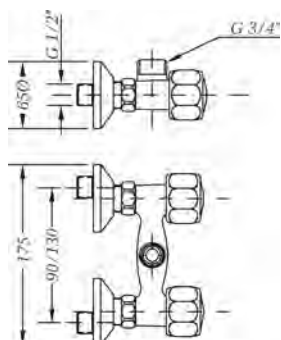

Ref.: 568195 45
 Cuerpo grupo mural 11cm
 Wall mounted mixer 11cm

Box: 1 | Carton: 20 | Pallet: 480



68995 11 100125 45 68998 11 45

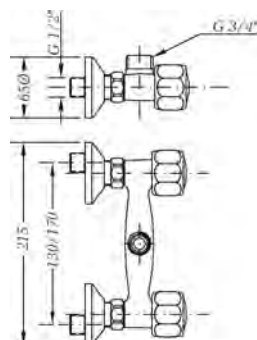

Ref.: 568193 45
 Cuerpo grupo mural 15cm
 Wall mounted mixer 15cm

Box: 1 | Carton: 20 | Pallet: 480



68995 11 100125 45 68998 11 45

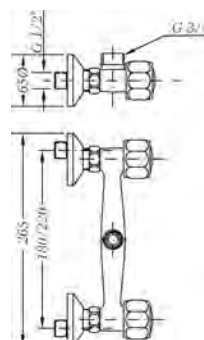

Ref.: 568104 45
 Cuerpo grupo mural 20cm
 Wall mounted mixer 20cm

Box: 1 | Carton: 15 | Pallet: 360



68995 11 100125 45 68998 11 45

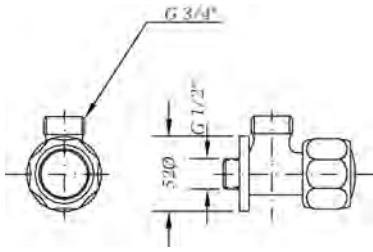

Ref.: 568083 45
Cuerpo grifo mural
Wall tap

Box: 1 | Carton: 80 | Palet: 1440



68995 11 | 68998 11 45

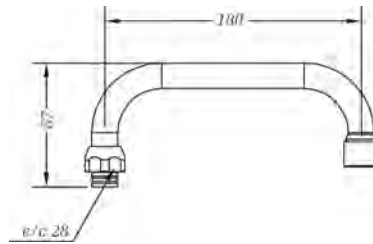

Ref.: 68901 45
Caño alto tubo 18 cm
High tube spout 18 cm

Box: 1 | Carton: 40 | Palet: 720



100088 45 | J68

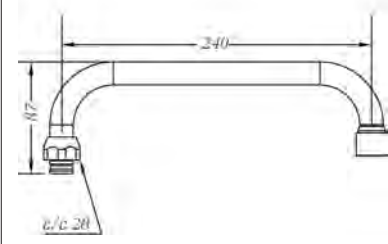

Ref.: 68902 45
Caño alto tubo 24 cm
High tube spout 24 cm

Box: 1 | Carton: 30 | Palet: 540



100088 45 | J68

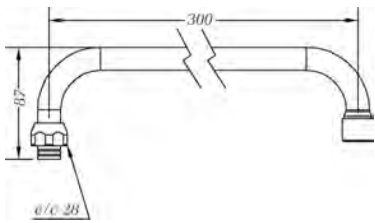

Ref.: 68908 45
Caño alto tubo 30 cm
High tube spout 30 cm

Box: 1 | Carton: 40 | Palet: 720



100088 45 | J68

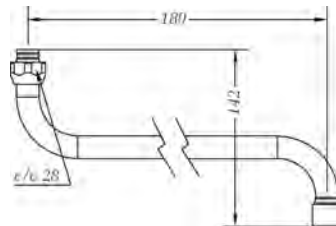

Ref.: 68910 45
Caño bajo tubo 18 cm
Low tube spout 18 cm

Box: 1 | Carton: 40 | Palet: 720



100088 45 | J68

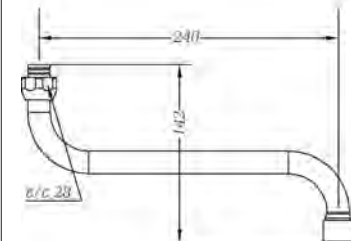

Ref.: 68904 45
Caño bajo tubo 24 cm
Low tube spout 24 cm

Box: 1 | Carton: 30 | Palet: 540



100088 45 | J68

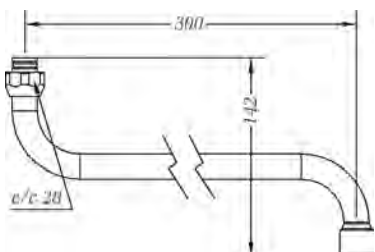

Ref.: 68909 45
Caño bajo tubo 30 cm
Low tube spout 30 cm

Box: 1 | Carton: 40 | Palet: 720



100088 45 | J68

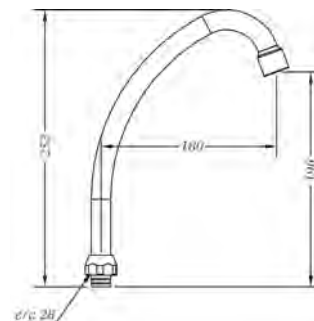

Ref.: 68903 45
Caño tubo vertical
Swan neck spout

Box: 1 | Carton: 30 | Palet: 540



100088 45 | J68

serie Kalo

Acabado cromado. Montura 1/4 vuelta cierre cerámico. | *Chromed finish. Ceramic headwork quarter turn.*

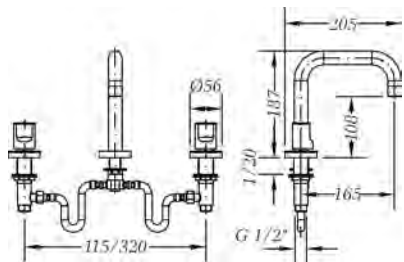

Ref.: 68120 07 45 66
Batería de lavabo caño recto
Widespread wash basin mixer with straight pipe

Box: 1



568120 45 68915 45 68998 07 45 67897 45 68995 09 100088 45

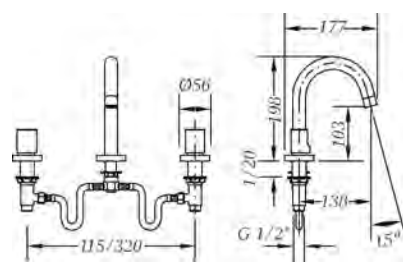

Ref.: 68124 07 45 66
Batería de lavabo caño cisne
Widespread wash basin mixer with swan neck pipe

Box: 1



568120 45 68916 45 68998 07 45 67897 45 68995 09 100088 45

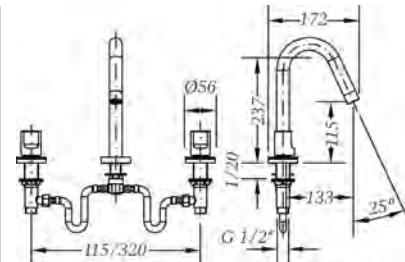

Ref.: 68125 07 45 66
Batería de lavabo caño inclinado
Widespread wash basin mixer with sloping pipe

Box: 1



568120 45 68917 45 68998 07 45 67897 45 68995 09 100088 45

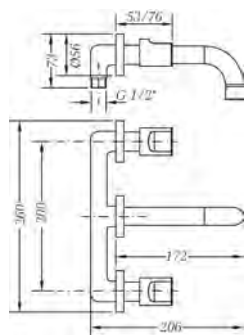

Ref.: 68131 07 45 66
Grupo de lavabo empotrado caño 16 cm
Built-in wash basin with 16cm pipe

Box: 1

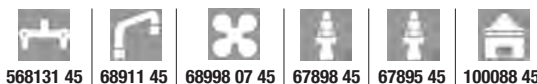

568131 45 68911 45 68998 07 45 67898 45 67895 45 100088 45

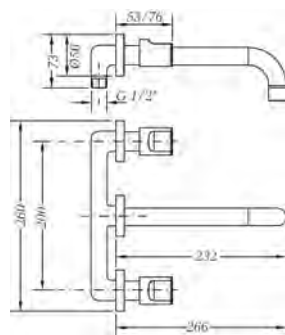

Ref.: 68132 07 45 66
Grupo de lavabo empotrado caño 22 cm
Built-in wash basin with 22cm pipe

Box: 1

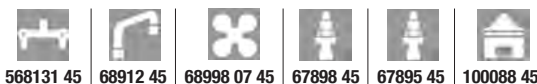

568131 45 68912 45 68998 07 45 67898 45 67895 45 100088 45



Ref.: 63114 30 45 66
Inversor cerámico 3 vías empotrado placa redonda
Built-in 3 way ceramic diverter with round plate

Box: 1



9908 0025 PR113 68998 30 45

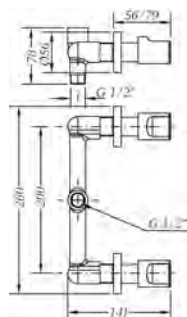

Ref.: 68115 07 45 66
Grupo ducha empotrada 8"
Built-in shower 8" shower mixer

Box: 1



568115 45 68998 07 45 67898 45 67895 45

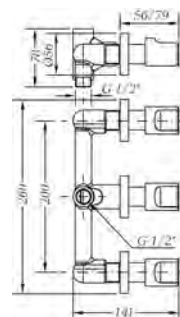

Ref.: 68116 07 45 66
Grupo baño empotrado 8" con inversor
Built-in 8" bath mixer with diverter

Box: 1



568116 45 68998 07 45 100173 45 67898 45 67895 45

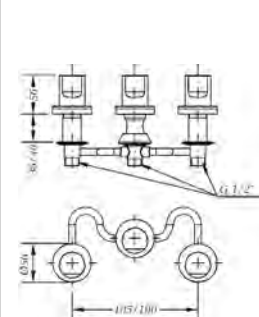

Ref.: 68142 07 45 66
Batería de bidé con transmisión
Widespread bidet mixer with transmission

Box: 1



568142 45 68998 07 45 67897 45 68995 09 100174 45

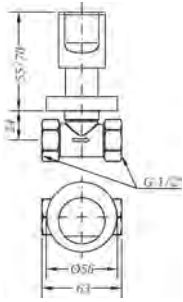

Ref.: 68170 07 45 66
Llave de paso 1/2"
Stopcock 1/2"

Box: 1



568170 45 | 68998 07 45 | 67895 45

serie Kross

Acabado cromado. Montura 1/4 vuelta cierre cerámico. | Chromed finish. Ceramic headwork quarter turn.

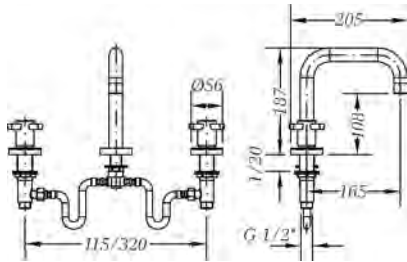

Ref.: 68120 08 45 66
Batería de lavabo caño recto
Widespread wash basin mixer with straight pipe

Box: 1



568120 45 | 68915 45 | 68998 08 45 | 67897 45 | 68995 09 | 100088 45

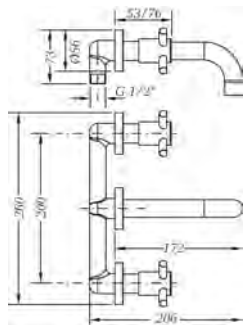

Ref.: 68131 08 45 66
Grupo de lavabo empotrado caño 16cm
Built-in wash basin with 16cm pipe

Box: 1



568131 45 | 68911 45 | 68998 08 45 | 67898 45 | 67895 45 | 100088 45

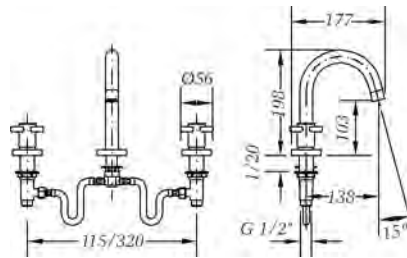

Ref.: 68124 08 45 66
Batería de lavabo caño cisne
Widespread wash basin mixer with swan neck pipe

Box: 1



568120 45 | 68916 45 | 68998 08 45 | 67897 45 | 68995 09 | 100088 45

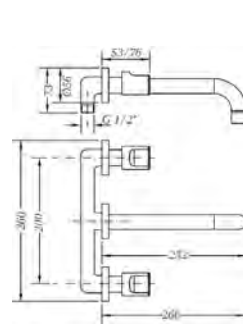

Ref.: 68132 08 45 66
Grupo de lavabo empotrado caño 22cm
Built-in wash basin with 22cm pipe

Box: 1



568131 45 | 68912 45 | 68998 08 45 | 67898 45 | 67895 45 | 100088 45

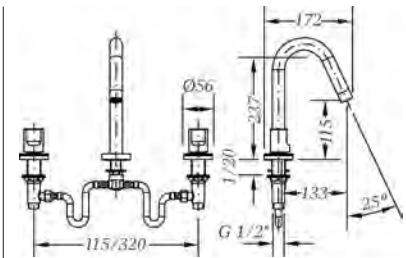

Ref.: 68125 08 45 66
Batería de lavabo caño inclinado
Widespread wash basin mixer with sloping pipe

Box: 1



568120 45 | 68917 45 | 68998 08 45 | 67897 45 | 68995 09 | 100088 45

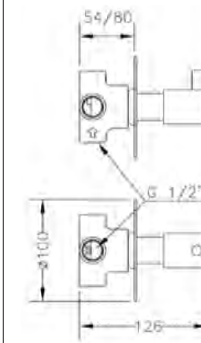

Ref.: 63114 30 45 66
Inversor cerámico 3 vías empotrado placa redonda
Built-in 3 way ceramic diverter with round plate

Box: 1



9908 0025 | PR113 | 68998 30 45

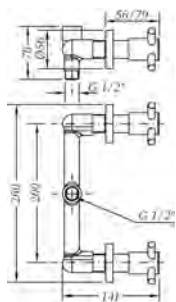

Ref.: 68115 08 45 66
 Grupo ducha empotrada 8"
 Built-in 8" shower mixer

Box: 1



568115 45 | 68998 08 45 | 67898 45 | 67895 45

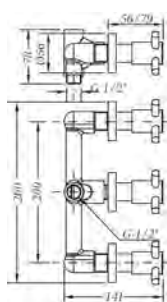

Ref.: 68116 08 45 66
 Grupo baño empotrada 8" con inversor
 Built-in 8" bath mixer with diverter

Box: 1



568116 45 | 68998 08 45 | 100173 45 | 67898 45 | 67895 45

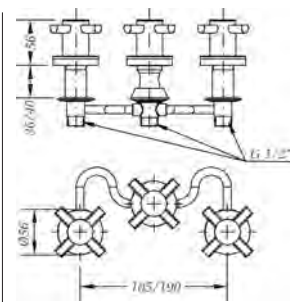

Ref.: 68142 08 45 66
 Batería de bidé con transmisión
 Widespread bidet mixer with transmission

Box: 1



568142 45 | 68998 08 45 | 67897 45 | 68995 09 | 100174 45

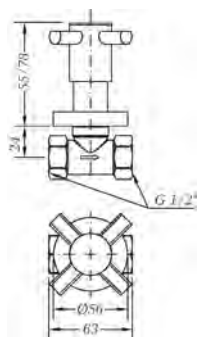

Ref.: 68170 08 45 66
 Llave de paso 1/2"
 Stopcock 1/2"

Box: 1



568170 45 | 68998 08 45 | 67895 45

serie Ixo

Acabado cromado. Montura 1/4 vuelta cierre cerámico. | Chromed finish. Ceramic headwork quarter turn.

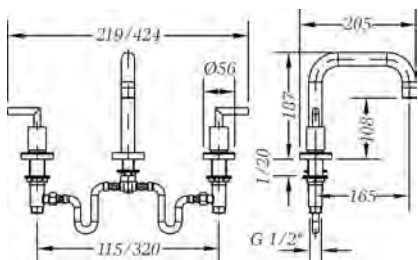

Ref.: 68120 12 45 66
 Batería de lavabo caño recto
 Widespread wash basin mixer with straight pipe

Box: 1



568120 45 | 68915 45 | 68998 12 45 | 67897 45 | 68995 09 | 100088 45

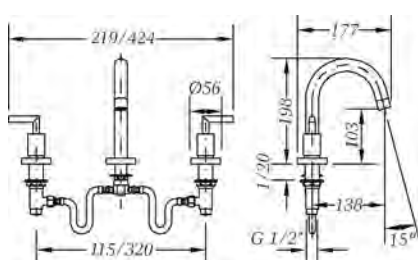

Ref.: 68124 12 45 66
 Batería de lavabo caño cisne
 Widespread wash basin mixer with swan neck pipe

Box: 1



568120 45 | 68916 45 | 68998 12 45 | 67897 45 | 68995 09 | 100088 45

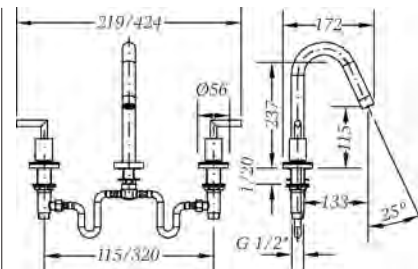

Ref.: 68125 12 45 66
 Batería de lavabo caño inclinado
 Widespread wash basin mixer with sloping pipe

Box: 1





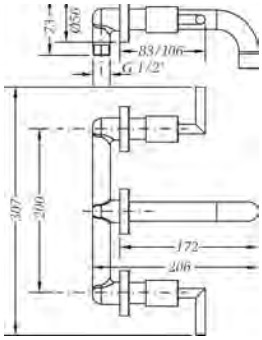



568120 45 | 68917 45 | 68998 12 45 | 67897 45 | 68995 09 | 100088 45



Ref.: 68131 12 45 66
 Grupo de lavabo empotrado caño 16 cm
Built-in wash basin with 16cm pipe





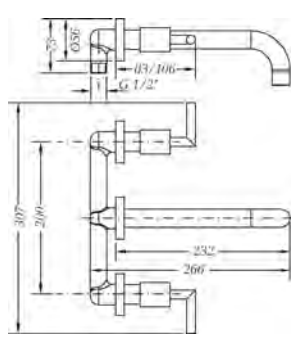

Box: 1

					
568131 45	68911 45	68998 12 45	67898 45	67895 45	100088 45



Ref.: 68132 12 45 66
 Grupo de lavabo empotrado caño 22 cm
Built-in wash basin with 22cm pipe



Box: 1

					
568131 45	68912 45	68998 12 45	67898 45	67895 45	100088 45



Ref.: 63114 30 45 66
 Inversor cerámico 3 vías empotrado placa redonda
Built-in 3 way ceramic diverter with round plate



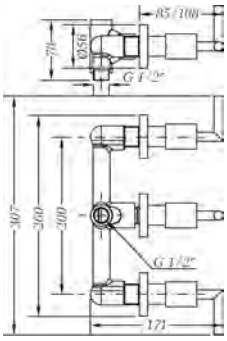

Box: 1

		
9908 0025	PR113	68998 30 45



Ref.: 68116 12 45 66
 Grupo baño empotrada 8" con inversor
Built-in 8" bath mixer with diverter



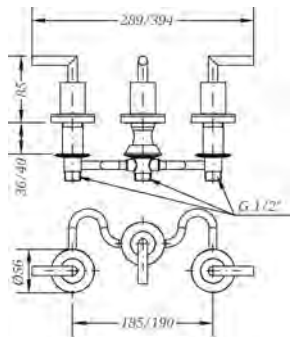

Box: 1

				
568116 45	68998 12 45	100173 45	67898 45	67895 45



Ref.: 68142 12 45 66
 Batería de bidé con transmisión
Widespread bidet mixer with transmission

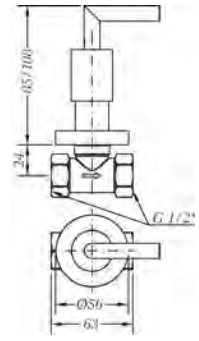

Box: 1

				
568142 45	68998 12 45	67897 45	68995 09	100174 45



Ref.: 68170 12 45 66
 Llave de paso 1/2"
Stopcock 1/2"

Box: 1

		
568170 45	68998 12 45	67895 45

Accesorios | Accessories

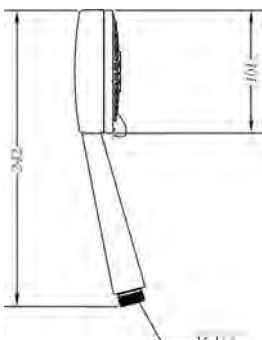

Ref.: DXK3 45
 Mango de ducha K3 jets (caja)
K3 jets handshower (box)

Box: 1 | Carton: 36 | Pallet: 324

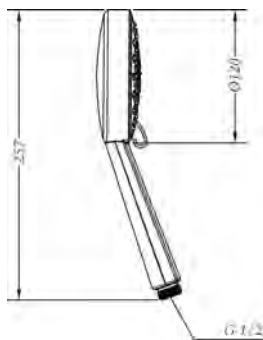

Ref.: DXT5 45
 Mango de ducha T5 jets (caja)
T5 jets handshower (box)

Box: 1 | Carton: 24 | Pallet: 288

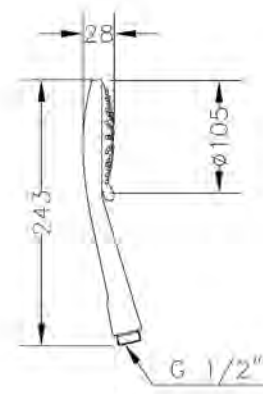

Ref.: DXT3 45
 Mango de ducha T3 jets (caja)
T3 jets handshower (box)

Box: 1 | Carton: 36 | Pallet: 324

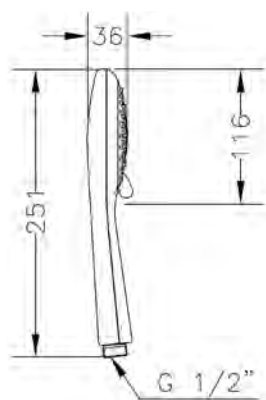

Ref.: DX03 45
Mango de ducha O3 jets (caja)
O3 jets handshower (box)

Box: 1 | Carton: 36 | Pallet: 324

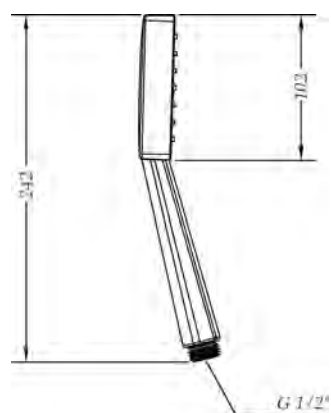

Ref.: DXK1 45
Mango de ducha K1 jets (caja)
K1 jet handshower (box)

Box: 1 | Carton: 36 | Pallet: 324

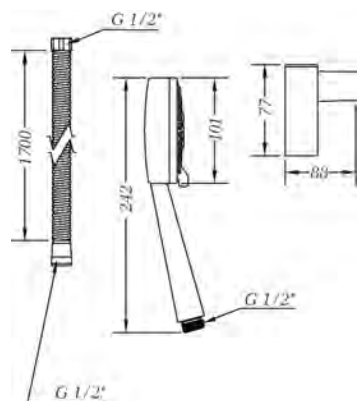

Ref.: 100698 45
Kit de ducha Kenjo, flexo, soporte y ducha 3 jets (caja)
Kenjo shower set, flexible hose, holder and 3 jets handshower (box)

Box: 1 Carton: 18 Pallet: 216

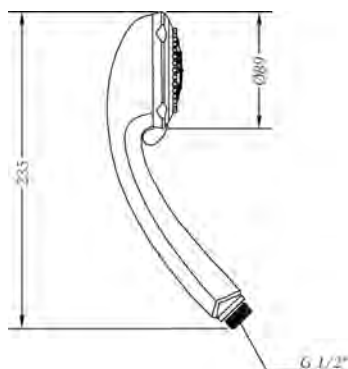

Ref.: DXE5 45
Mango de ducha E5 jets (caja)
E5 jets handshower (box)

Box: 1 | Carton: 45 | Pallet: 405

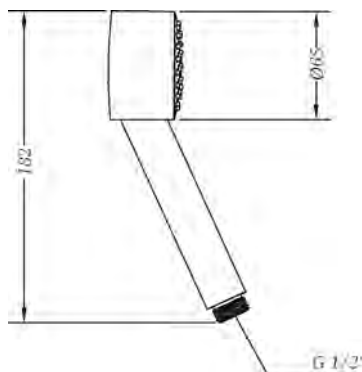

Ref.: 100197 45 00
Mango de ducha C1 jet (bolsa)
C1 jet handshower (bag)

Box: 1 | Carton: 100 | Pallet: 1800

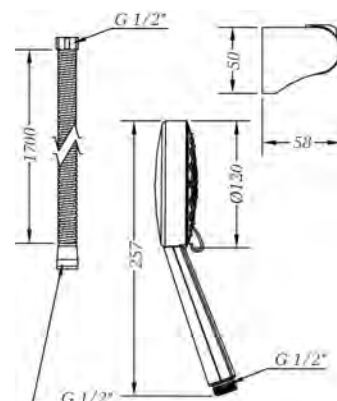

Ref.: 100699 45
Kit de ducha Tau, flexo, soporte y ducha 5 jets (caja)
Tau shower set, flexible hose, holder and 5 jets handshower (box)

Box: 1 Carton: 18 Pallet: 216

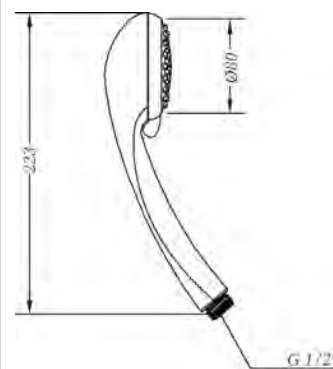

Ref.: DXE2 45
Mango de ducha E2 jets (caja)
E2 jets handshower (box)

Box: 1 | Carton: 45 | Pallet: 540

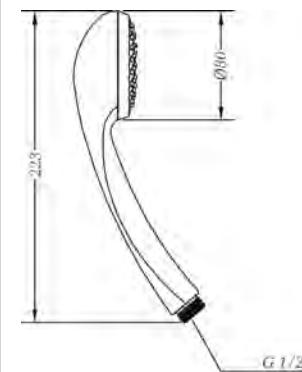

Ref.: 100175 45 00
Mango de ducha E1 jet (bolsa)
E1 jet handshower (bag)

Box: 1 | Carton: 60 | Pallet: 1080

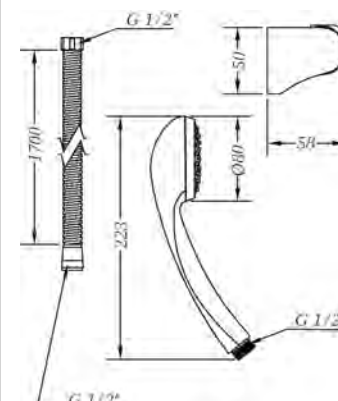

Ref.: 100697 45
Kit de ducha GE2, flexo, soporte y ducha 1 jet (caja)
GE2 shower set, flexible hose, holder and 1 jet handshower (box)

Box: 1 Carton: 18 Pallet: 216

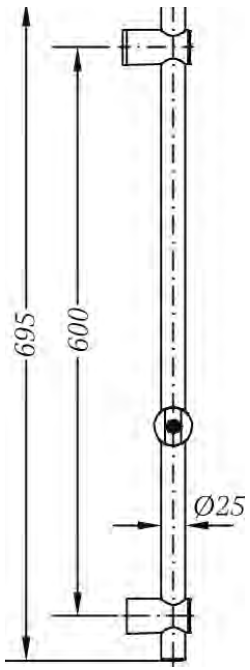

Ref.: 1748 45
 Conjunto Tau, barra, flexo y ducha 5 jets (caja)
Tau set, bar, hose and 5 jets handshower (box)

Box: 1 Carton: 10 Pallet: 60

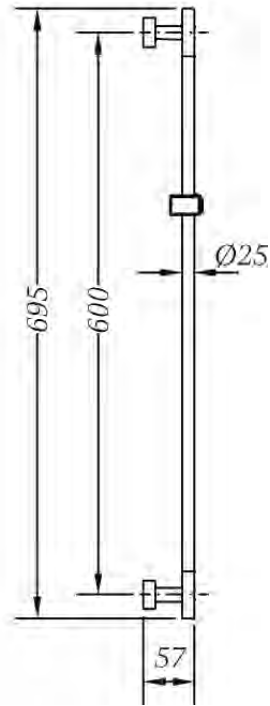

Ref.: 1747 45
 Conjunto Kenjo, barra, flexo y ducha 3 jets (caja)
Kenjo set, bar, flexible hose and 3 jets handshower (box)

Box: 1 Carton: 10 Pallet: 60

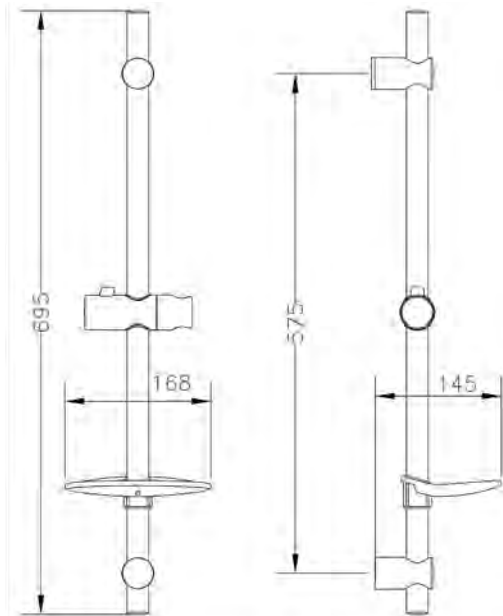

Ref.: 1636 45
 Barra ducha TAU (caja)
TAU shower bar (box)

Box: 1 | Carton: 10 | Pallet: 90

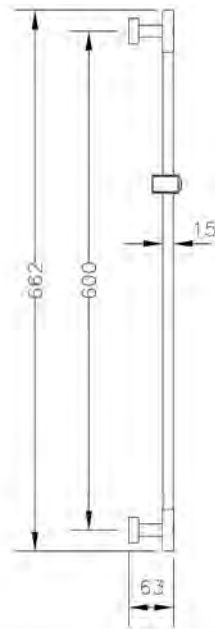

Ref.: 1637 45
 Barra ducha Kenjo (caja)
Kenjo shower bar (box)

Box: 1 | Carton: 10 | Pallet: 60

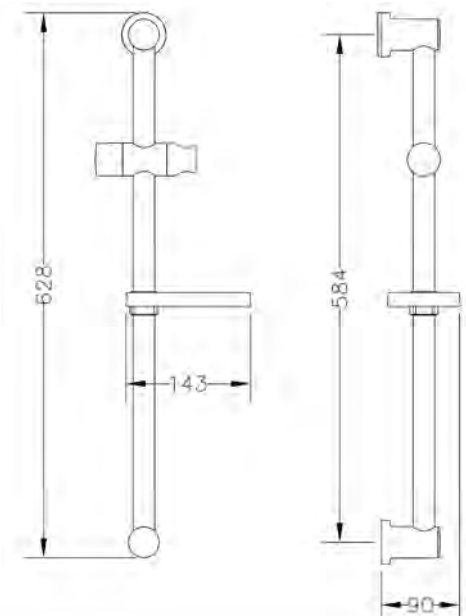

Ref.: 1638 45
 Barra ducha redonda (caja)
Round shower bar (box)

Box: 1 | Carton: 10 | Pallet: 100

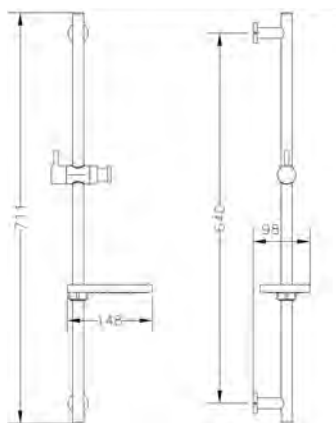

Ref.: 1639 45
Barra ducha metálica (caja)
Metallic shower bar (box)

Box: 1 | Carton: 10 | Pallet: 60



Ref.: 100140 30
Flexo 1,70 m. PVC antirrotura y tuerca loca
PVC flexible hose 1,70 m anti-breaking and swiveling nut

Box: 1 | Carton: 24 | Pallet: 432

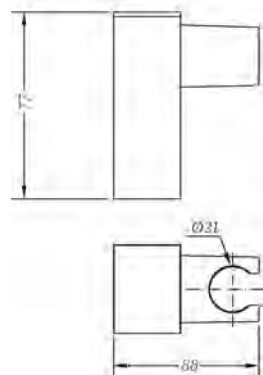

Ref.: 100149 45
Soporte ducha Kenjo
Kenjo shower holder

Box: 1 | Carton: 100 | Palet: 2700

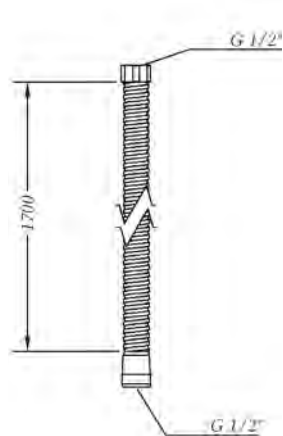

Ref.: 100135 60 00
Flexo 1,70 m inoxidable
Stainless steel flexible hose 1,70 m

Box: 1 | Carton: 50 | Pallet: 900

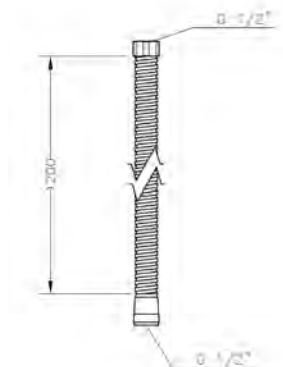

Ref.: 100141 45
Flexo 1,20 m inoxidable
Stainless steel flexible hose 1,20 m

Box: 1 | Carton: 50 | Pallet: 900

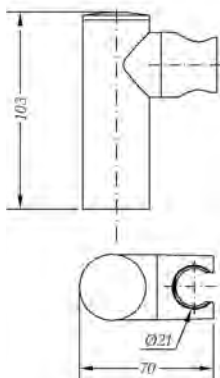

Ref.: 100153 45
Soporte ducha cilíndrico
Cylindrical shower holder

Box: 1 | Carton: 230 | Pallet: 2760

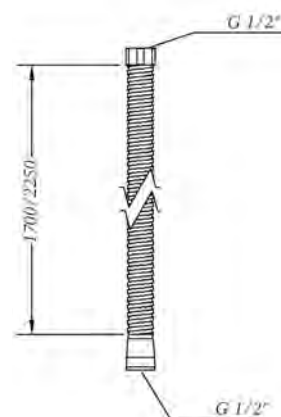

Ref.: 100137 60 00
Flexo extensible 1,70 - 2,25 m inoxidable doble grapaje
Extendible stainless steel flexible hose 1,70 to 2,25 m double lock

Box: 1 | Carton: 50 | Pallet: 900

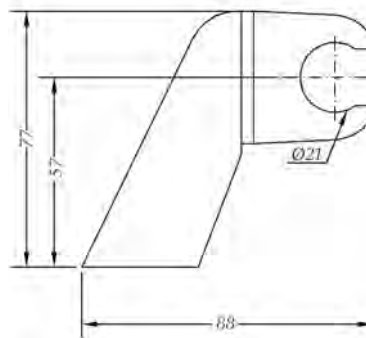

Ref.: 100152 45
Soporte ducha Combi
Combi shower holder

Box: 1 | Carton: 150 | Pallet: 2700

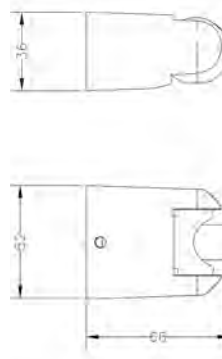

Ref.: 100068 45
Soporte ducha ovalado
Oval shower holder

Box: 1 | Carton: 150 | Pallet: 1800

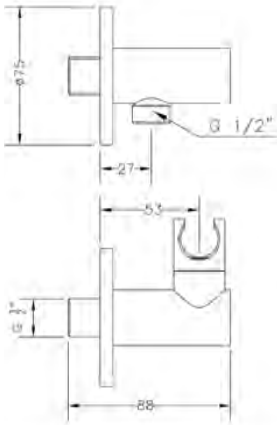

Ref.: 1633 04
Soporte ducha con toma cilindrico
Round shower holder with flexible connector

Box: 1 | Carton: 75 | Pallet: 1800

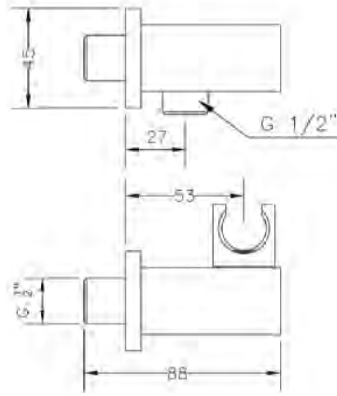

Ref.: 1649 04
Soporte ducha con toma cuadrado
Square shower holder with flexible connector

Box: 1 | Carton: 50 | Pallet: 1600

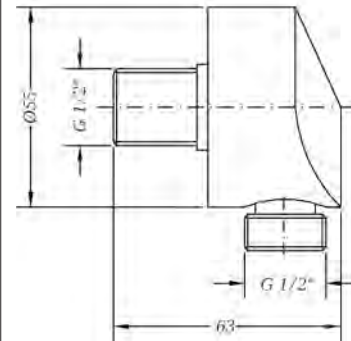

Ref.: 1680 04
Toma ducha mural redonda
Round wall flexible connector

Box: 1 | Carton: 96 | Pallet: 2304

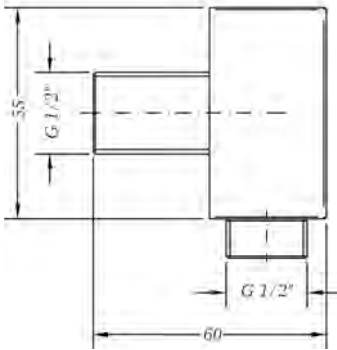

Ref.: 1679 04
Toma ducha mural cuadrada
Square wall flexible connector

Box: 1 | Carton: 96 | Pallet: 2304

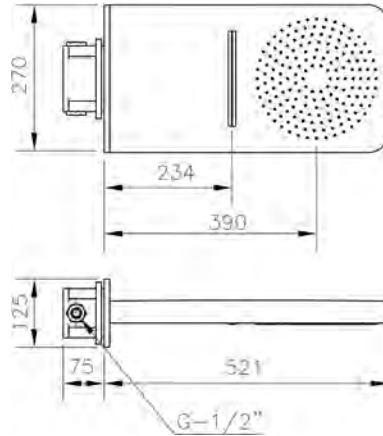

Ref.: 1643 45
Rociador doble función cascada-lluvia
Shower head double function waterfall-rain

Box: 1 | Carton: 2 | Pallet: 24

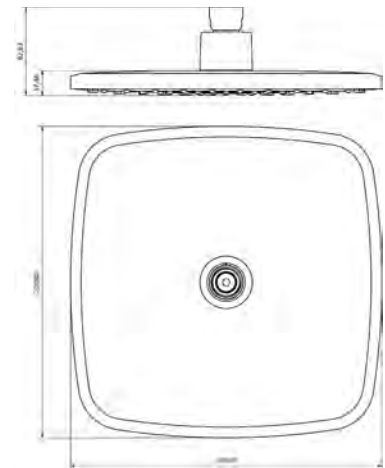

Ref.: R63112 08
Rociador ovalado 22 cm
Oval shower head 22 cm

Box: 1

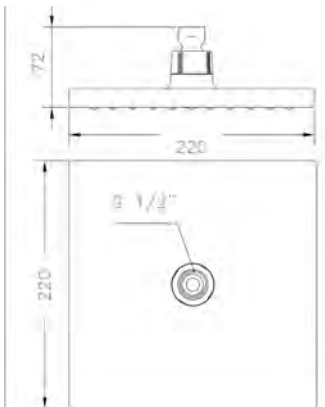

Ref.: R63112 26
Rociador cuadrado 22 cm
Square shower head 22 cm

Box: 1 | Carton: 24 | Pallet: 144

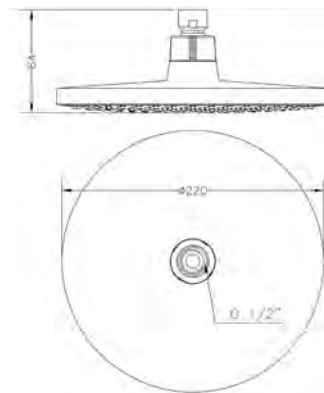

Ref.: R65112 18
Rociador redondo 22 cm
Round shower head Ø 22 cm

Box: 1 | Carton: 24 | Pallet: 144

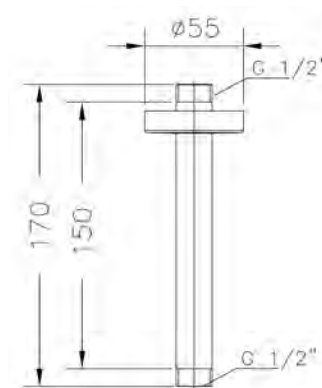

Ref.: 1671 45
Brazo a techo redondo 15 cm
Round roof arm 15 cm

Box: 1 | Carton: 70 | Pallet: 1260

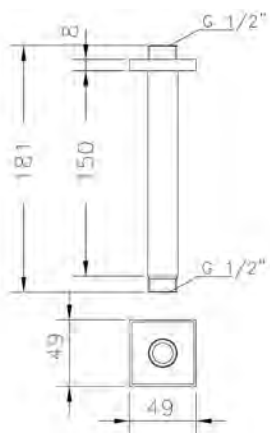

Ref.: 1672 45
 Brazo a techo cuadrado 15 cm
 Square roof arm 15 cm

Box: 1 | Carton: 108 | Pallet: 1944

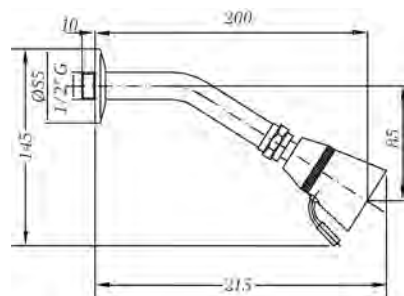

Ref.: 1698 45
 Rociador ducha con brazo
 Wall shower arm and spray

Box: 1 | Carton: 15 | Pallet: 480

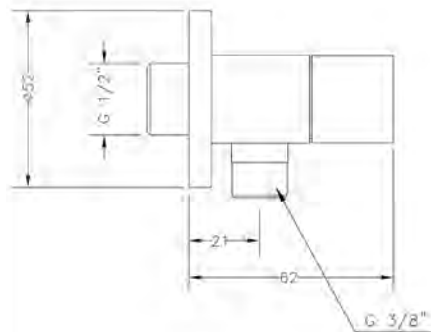

Ref.: 3106 04
 Válvula de escuadra cuadrada 3/8\"/>

Box: 2 | Carton: 120 | Pallet: 4320

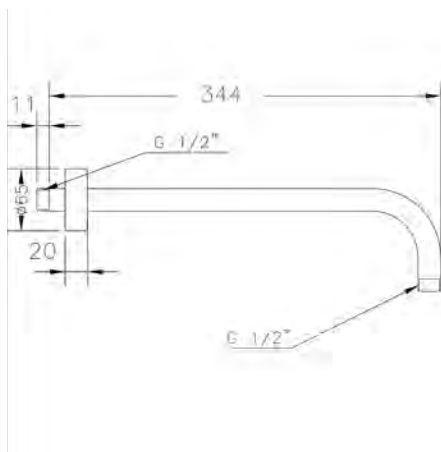

Ref.: B65113 18
 Brazo pared redondo 35 cm
 Round arm 35 cm

Box: 1 | Carton: 20 | Pallet: 360

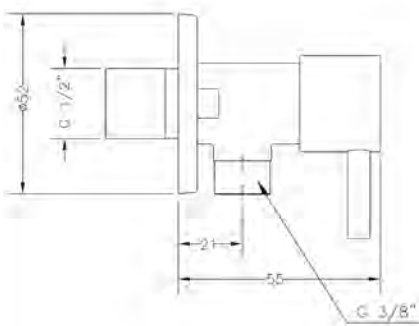

Ref.: 3104 04
 Válvula de escuadra redonda 3/8\"/>

Box: 2 | Carton: 120 | Pallet: 4320

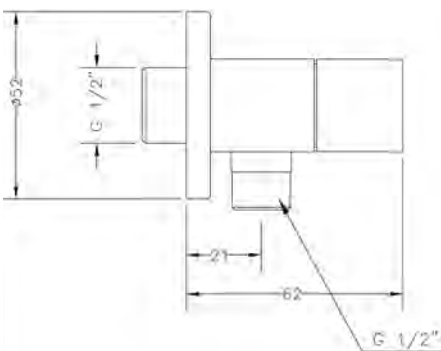

Ref.: 3106 05
 Válvula de escuadra cuadrada 1/2\"/>

Box: 2 | Carton: 120 | Pallet: 4320

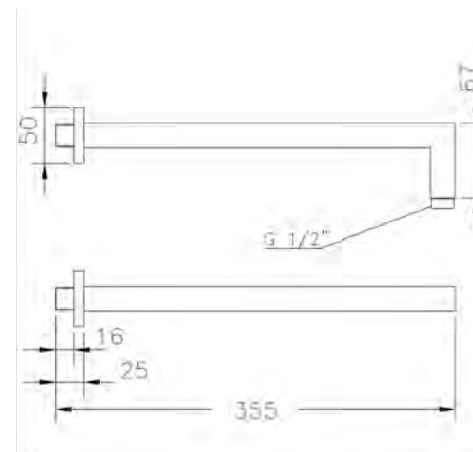

Ref.: B63113 26
 Brazo pared cuadrado 35 cm
 Square wall arm 35 cm

Box: 1 | Carton: 20 | Pallet: 360

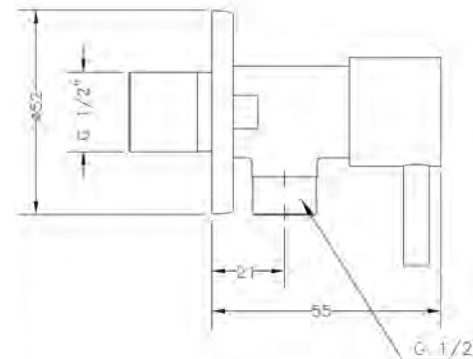

Ref.: 3104 05
 Válvula de escuadra redonda 1/2\"/>

Box: 2 | Carton: 120 | Pallet: 4320

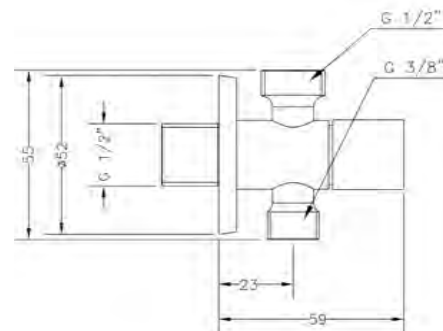

Ref.: 3107 03
 Válvula de escuadra doble 1/2\"/>

Box: 1 | Carton: 160 | Pallet: 3840

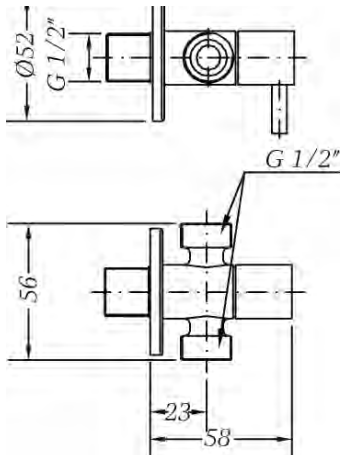

Ref.: 3107 04
 Válvula de escuadra doble 1/2" - 1/2" ducha-inodoro
 Double angle valve 1/2" - 1/2" shower-WC

Box: 1 | Carton: 16 | Pallet: 3840

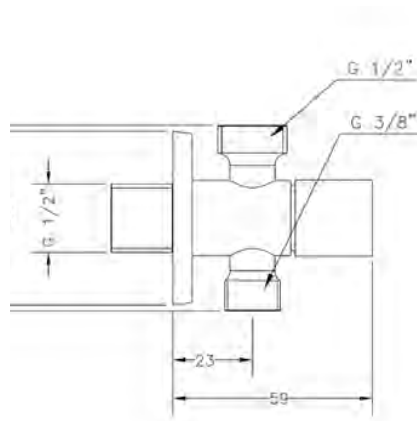

Ref.: 3108 03
 Válvula de escuadra doble 1/2" - 3/8" ducha-inodoro Inox
 Inox double angle valve 1/2" - 3/8" shower-WC

Box: 1 | Carton: 16 | Pallet: 3840

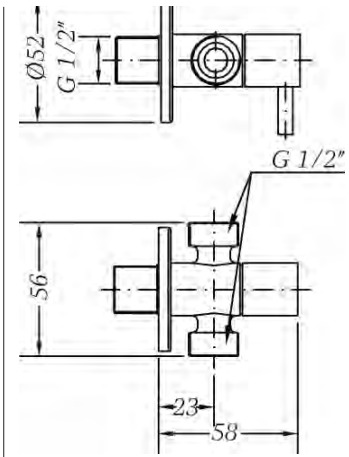

Ref.: 3108 04
 Válvula de escuadra doble 1/2" - 1/2" ducha-inodoro Inox
 Inox double angle valve 1/2" - 1/2" shower-WC

Box: 1 | Carton: 16 | Pallet: 3840

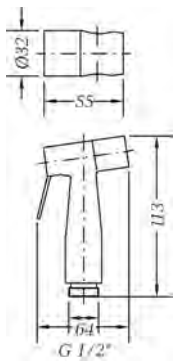

Ref.: 100694 45
 Kit ducha sanitaria
 Sanitary shower kit

Box: 1 | Carton: 22 | Pallet: 268

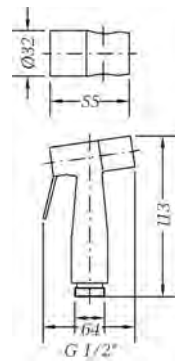

Ref.: 100694 60
 Kit ducha sanitaria. Inox
 Inox sanitary shower kit

Box: 1 | Carton: 22 | Pallet: 268

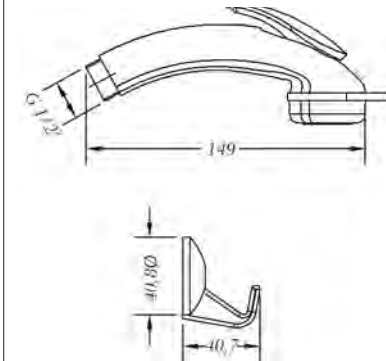

Ref.: 100696 45
 Kit soporte y ducha sanitaria
 holder and sanitary shower kit

Box: 1 | Carton: 100 | Pallet: 1800

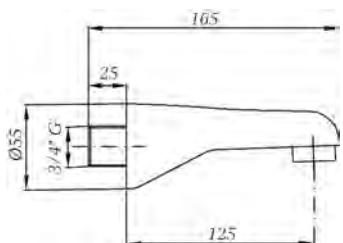

Ref.: 1667 45
 Caño mural baño fundido
 Casted wall bath spout

Box: 1 | Carton: 60 | Pallet: 1080

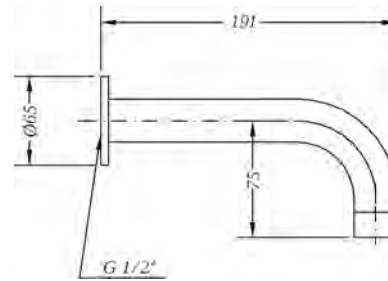

Ref.: 1668 45
 Caño mural baño cilíndrico
 Round wall bath spout

Box: 1 | Carton: 20 | Pallet: 240

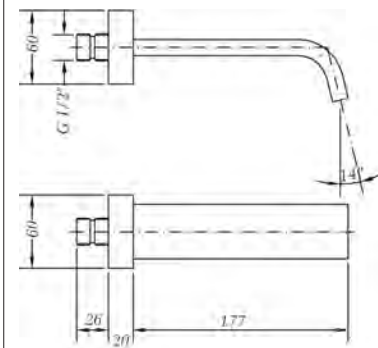

Ref.: 1674 45
 Caño mural baño cuadrado
 Square wall bath spout

Box: 1 | Carton: 24 | Pallet: 720

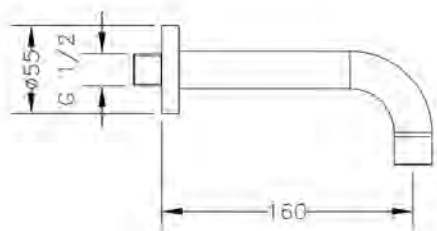

Ref.: 68911 45
Caño mural tubo recto 16 cm
Wall mounted pipe spout 16 cm

Box: 1 | Carton: 40 | Pallet: 640

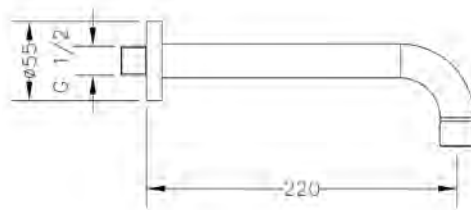

Ref.: 68912 45
Caño mural tubo recto 22 cm
Wall mounted pipe spout 22 cm

Box: 1 | Carton: 40 | Pallet: 640

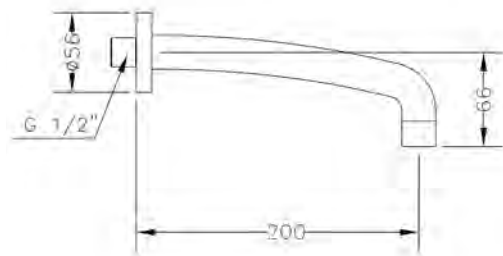

Ref.: 68913 45
Caño mural tubo inclinado 20 cm
Wall mounted sloping pipe spout 20 cm

Box: 1 | Carton: 40 | Pallet: 640

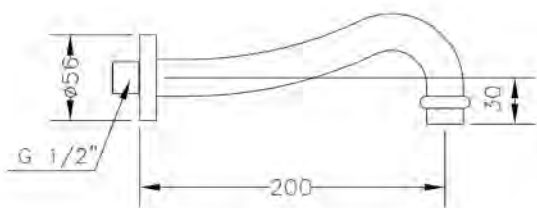

Ref.: 68914 45
Caño mural tubo retro 20 cm
Wall mounted retro pipe spout 20 cm

Box: 1 | Carton: 40 | Pallet: 640

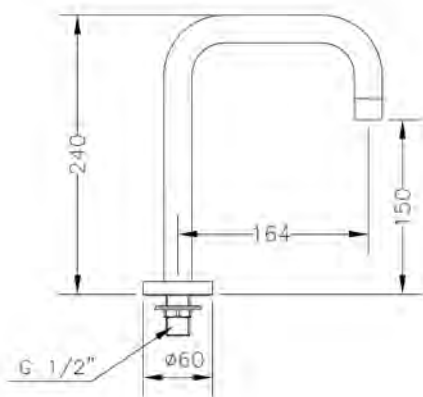

Ref.: 68915 45
Caño encimera recto tubo
Straight pipe spout

Box: 1 | Carton: 30 | Pallet: 480

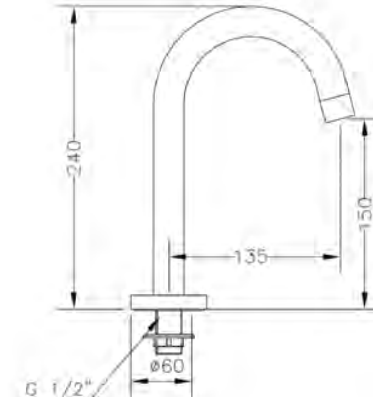

Ref.: 68916 45
Caño encimera cisne tubo
Swan neck pipe spout

Box: 1 | Carton: 30 | Pallet: 480

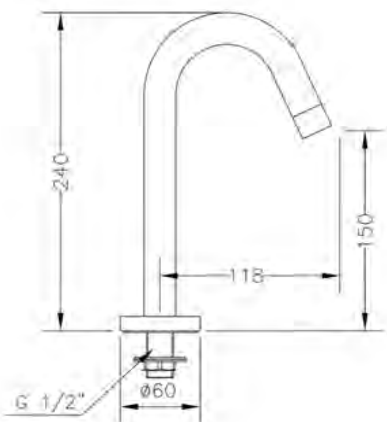

Ref.: 68917 45
Caño encimera inclinado tubo
Sloping pipe spout

Box: 1 | Carton: 30 | Pallet: 480

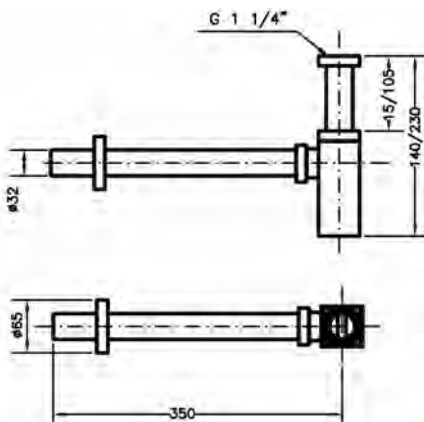

Ref.: 1621 07
Sifon botella para lavabo y bidé 1 1/4"
1 1/4" bidet and basin siphon

Box: 1 | Carton: 12 | Pallet: 216

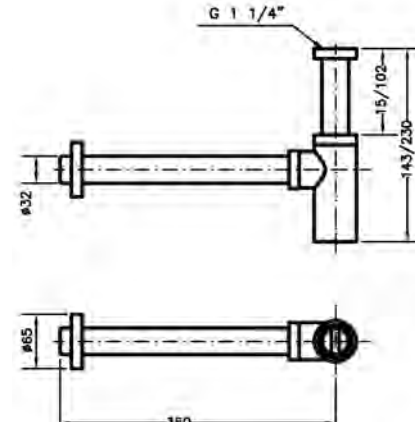

Ref.: 1622 07
Sifon botella para lavabo y bidé 1 1/4"
1 1/4" bidet and basin siphon

Box: 1 | Carton: 12 | Pallet: 216

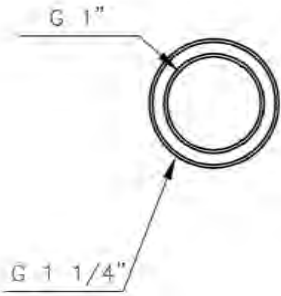

Ref.: 9908 0046
 Adaptador sifon 1 1/4" - 1"
Siphon adaptor 1 1/4" - 1"

Box: 1

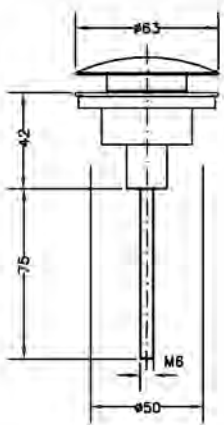

Ref.: 100202 45
 Tapa universal "Click remove"
"Click remove" universal cover

Box: 1 | Carton: 60 | Pallet: 1080

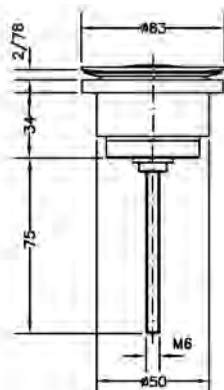

Ref.: 100205 45
 Válvula click universal 1 1/4"
1 1/4" universal click valve

Box: 1 | Carton: 60 | Pallet: 1080

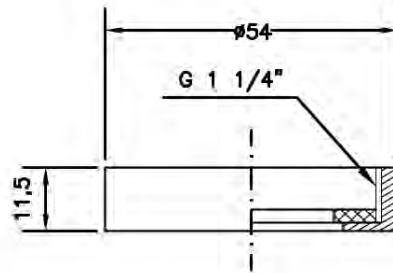

Ref.: 100134 07
 Tuerca para sifón 1 1/4"
1 1/4" siphon nut

Box: 1 | Carton: 30 | Pallet: 8640

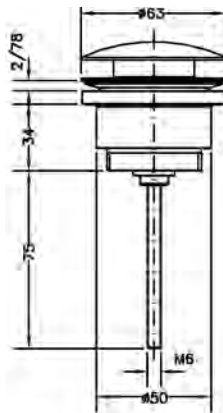

Ref.: 100211 45
 Válvula click "Luxe" 1 1/4"
1 1/4" "Luxe" click valve

Box: 1 | Carton: 60 | Pallet: 1080

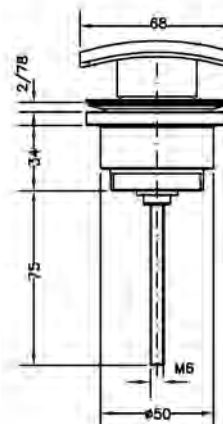

Ref.: 100204 45
 Válvula click Kenjo 1 1/4"
1 1/4" Kenjo click valve

Box: 1 | Carton: 60 | Pallet: 1080

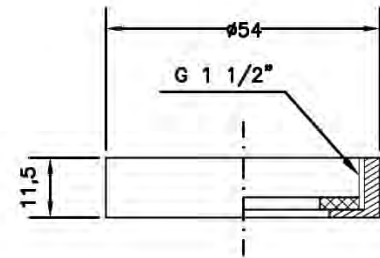

Ref.: 100134 08
 Tuerca para sifón 1 1/2"
1 1/2" siphon nut

Box: 1 | Carton: 30 | Pallet: 8640

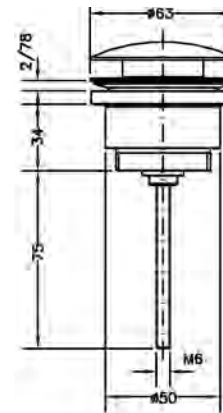

Ref.: 100211 43
 Válvula click "Luxe" bronce 1 1/4"
1 1/4" "Luxe" click valve bronze

Box: 1 | Carton: 60 | Pallet: 1080

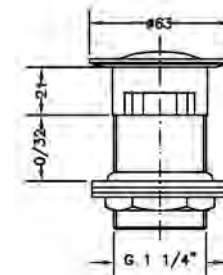

Ref.: 100206 45
 Válvula click 1 1/4" con rebosadero
1 1/4" click valve with overflow

Box: 1 | Carton: 60 | Pallet: 1080

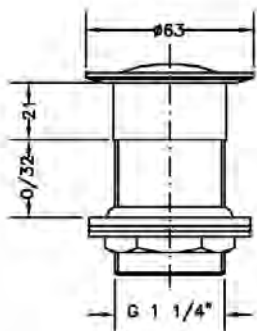

Ref.: 100207 45
Válvula click 1 1/4"
1 1/4" click valve

Box: 1 | Carton: 60 | Pallet: 1080

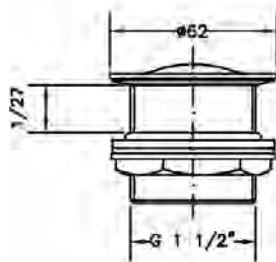

Ref.: 100208 45
Válvula click 1 1/4" bañera
1 1/4" bath click valve

Box: 1 | Carton: 60 | Pallet: 1080

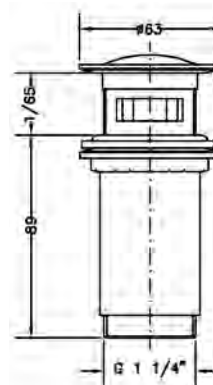

Ref.: 100209 45
Válvula click 1 1/4" con/sin rebosadero
1 1/4" click valve with/out overflow

Box: 1 | Carton: 60 | Pallet: 1080

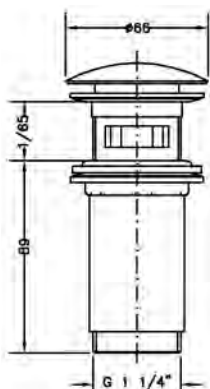

Ref.: 100210 45
Válvula click 1 1/4" con/sin rebosadero
1 1/4" click valve with/out overflow

Box: 1 | Carton: 60 | Pallet: 1080

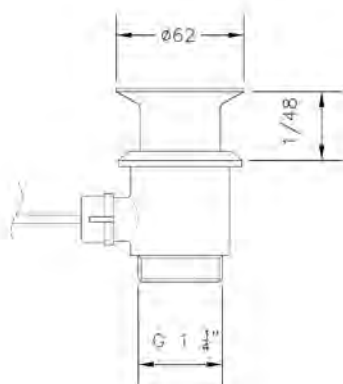

Ref.: 100200 45
Válvula automática plástico 1 1/4"
1 1/4" Plastic automatic valve

Box: 1

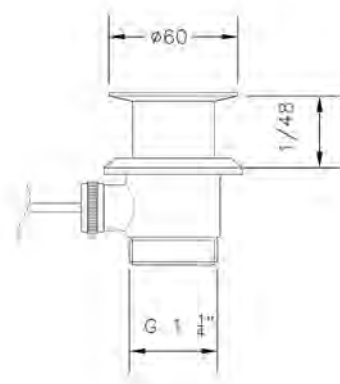

Ref.: 100203 45
Válvula automática metálica 1 1/4"
1 1/4" Metallic automatic valve

Box: 1

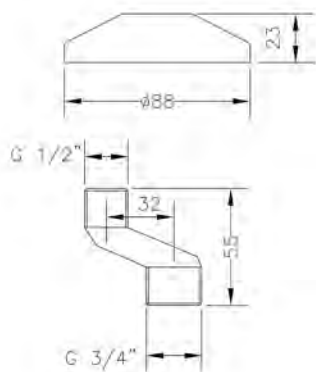

Ref.: 100122 45
Conjunto florón y excéntricas gigantes
Giant escutcheon eccentric set

Box: 1 | Carton: 72 | Pallet: 1728

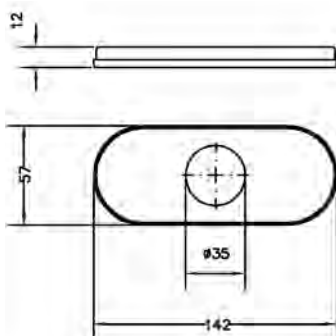

Ref.: P130
Placa adaptadora 4"
4" adaptor plate

Box: 5 | Carton: 240 | Pallet: 4320

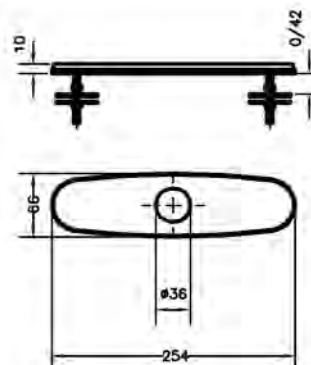

Ref.: P200
Placa adaptadora 8"
8" adaptor plate

Box: 5 | Carton: 100 | Pallet: 3600

Índice por referencia | *Index by reference*

Ref.:	Serie	<i>Technic</i>	Ref.:	Serie	<i>Technic</i>	Ref.:	Serie	<i>Technic</i>	Ref.:	Serie	<i>Technic</i>
3104	136	196	100697 45	129	196	60001 22 45 67	72	182	62115 31 45 66	10	155
3106	136	196	100698 45	129	192	60100 06 45 66	77	174	62117 31 45 66	10	155
3107	136	196 / 197	100699 45	129	192	60100 22 45 66	69	175	62118 08 45 66	10	155
3108	136	197	1007 04	81	192	60110 06 45 66	77	173	62130 08 45 66	8	155
100134	139	199	1008 04	71	177	60110 22 45 66	69	175	62131 31 45 66	8	154
100068 45	133	194	1009 04	71	174	60130 22 45 66	68	173	62132 31 45 66	8	154
100122 45	142	200	1023 04	72	174	60130 22 45 66	76	173	62136 08 45 66	8	155
100135 60 00	132	194	1024 04	72	174	60140 06 45 66	76	175	62140 08 45 66	9	154
100137 60 00	132	194	1621 07	139	174	60140 22 45 66	68	175	62142 31 45 66	9	155
100140 30	132	194	1622 07	139	198	60188 06 45 66	76	173	63100 26 45 67	59	155
100141 45	72	174	1633 04	133	198	60188 22 45 66	68	175	63110 26 45 67	59	170
100141 45	132	194	1636 45	131	195	60194 06 45 66	81	173	63114 30 45 66	111	170
100149 45	133	194	1637 45	130	193	60198 05 45 66	81	177	63114 30 45 66	115	188
100152 45	133	194	1638 45	131	193	60199 05 45 66	81	177	63114 30 45 66	119	189
100153 45	133	194	1639 45	131	193	61115 06 45 66	77	177	63115 26 45 66	59	191
100175 45 00	129	192	1643 45	134	194	61115 22 45 66	69	175	63116 26 45 66	59	170
100197 45 00	129	192	1649 04	133	195	61116 06 45 66	77	173	63130 26 45 66	56	170
1002 04	71	174	1667 45	137	195	61116 22 45 66	69	175	63131 26 45 66	58	169
100200 45	141	200	1668 45	137	197	61130 06 45 66	76	173	63132 26 45 66	58	169
100202 45	140	199	1671 45	134	197	61130 22 45 66	68	175	63134 26 45 66	56	169
100203 45	141	200	1672 45	134	195	61142 06 45 66	76	173	63136 26 45 66	56	169
100204 45	140	199	1674 45	137	196	61142 22 45 66	68	175	63137 26 45 66	56	169
100205 45	140	199	1679 04	134	197	61190 06 45 66	80	173	63138 26 45 66	56	169
100206 45	140	199	1680 04	134	195	61192 06 45 66	80	176	63140 26 45 66	58	169
100207 45	141	200	1698 45	135	195	61195 06 45 66	80	176	63142 26 45 66	58	169
100208 45	141	200	1745 45	44	196	61196 06 45 66	80	176	64100 04 45 66	36	169
100209 45	141	200	1746 45	61	165	61200 06 45 66	80	177	64100 14 45 66	29	162
100210 45	141	200	1747 45	130	171	61201 06 45 66	79	177	64100 16 45 66	21	160
100211 43	140	199	1748 45	130	193	61203 06 45 66	79	176	64110 04 45 66	36	158
100211 45	140	199	568083 45	106	193	61204 06 45 66	79	176	64110 14 45 66	29	162
1003 04	71	174	568104 45	106	187	61205 06 45 66	79	176	64110 16 45 66	21	160
1005 04	71	174	568193 45	105	186	61206 06 45 66	79	176	64111 14 45 67	43	158
1006 04	81	177	568195 45	105	186	61210 06 45 66	79	176	64113 14 45 67	43	165
100694 45	137	197	568550 45	95	186	61900 06 45 66	80	176	64114 14 45 67	43	165
100696 45	72	174	568555 45	95	182	62100 08 45 67	9	177	64115 14 45 66	30	165
100696 45	137	197	568565 45	95	182	62110 31 45 67	9	155	64115 16 45 66	22	161
100696 60	137	196	568575 45	95	182	62114 30 45 66	10	155	64115 16 45 66	36	159

Ref.:	Serie	<i>Technic</i>	Ref.:	Serie	<i>Technic</i>	Ref.:	Serie	<i>Technic</i>	Ref.:	Serie	<i>Technic</i>
64116 14 45 66	30	162	65115 19 45 66	16	164	65207 18 60 66	64	166	68125 07 45 66	110	190
64116 16 45 66	22	161	65115 29 45 66	52	157	65208 18 60 66	64	172	68125 08 45 66	114	188
64117 04 45 66	36	159	65116 18 45 66	42	168	65211 18 60 66	64	172	68125 12 45 66	118	189
64118 04 45 66	36	162	65116 19 45 66	16	164	65702 18 45 66	46	172	68130 11 45 66	100	190
64130 04 45 66	35	162	65116 29 45 66	52	157	65900 18 45 66	46	166	68131 07 45 66	110	183
64130 14 45 66	28	161	65117 18 45 66	42	168	67100 26 45 67	60	166	68131 08 45 66	114	188
64130 16 45 66	20	160	65118 18 45 66	42	164	67102 14 45 67	43	170	68131 09 45 66	92	189
64131 14 45 66	28	158	65130 19 45 66	14	164	67103 14 45 67	22	164	68131 11 45 66	102	180
64131 16 45 66	20	160	65131 18 45 66	40	156	67104 14 45 67	22	159	68131 12 45 66	118	184
64132 14 45 66	28	158	65131 19 45 66	14	163	67110 26 45 67	60	159	68132 07 45 66	110	191
64132 16 45 66	20	160	65131 29 45 66	50	156	67112 14 45 67	43	170	68132 08 45 66	114	188
64134 04 45 66	35	158	65132 18 45 66	40	167	68001 09 45 66	92	164	68132 12 45 66	118	189
64134 14 45 66	28	161	65132 19 45 66	14	163	68001 11 45 66	102	180	68140 11 45 66	101	191
64134 16 45 66	20	160	65132 29 45 66	50	156	68003 11 45 66	104	185	68142 07 45 66	111	184
64136 04 45 66	35	158	65134 18 45 66	40	167	68083 11 45 66	104	186	68142 08 45 66	115	188
64136 14 45 66	28	161	65134 19 45 66	14	163	68093 11 45 66	104	186	68142 09 45 66	91	190
64136 16 45 66	20	160	65134 29 45 66	50	156	68100 11 45 66	101	186	68142 11 45 66	101	180
64140 04 45 66	35	158	65135 18 45 66	40	167	68103 11 45 66	104	184	68142 12 45 66	119	184
64140 14 45 66	29	162	65135 29 45 66	50	163	68104 11 45 66	104	185	68160 11 45 66	101	191
64140 16 45 66	21	160	65136 18 45 66	40	167	68110 11 45 66	101	186	68170 07 45 66	111	184
64142 14 45 66	29	158	65136 19 45 66	14	163	68115 07 45 66	111	184	68170 08 45 66	115	189
64142 16 45 66	21	160	65136 29 45 66	50	156	68115 08 45 66	115	188	68170 11 45 66	102	190
64142 16 45 66	35	158	65138 18 45 66	40	167	68115 11 45 66	102	190	68170 12 45 66	119	185
64192 16 45 66	24	162	65140 19 45 66	15	163	68115 12 45 66	119	184	68180 11 45 66	100	191
64201 04 45 66	37	159	65142 18 45 66	41	156	68116 07 45 66	111	191	68190 11 45 66	103	184
64201 14 45 66	30	162	65142 19 45 66	15	163	68116 08 45 66	115	188	68193 11 45 66	103	185
64201 16 45 66	24	161	65142 29 45 66	51	156	68116 11 45 66	102	190	68194 09 45 66	94	185
64206 14 45 66	30	159	65145 18 45 66	41	168	68116 12 45 66	119	184	68194 11 45 66	105	181
64206 16 45 66	24	161	65145 29 45 66	51	163	68120 07 45 66	110	191	68195 11 45 66	103	186
65100 18 45 66	41	159	65192 18 45 66	47	167	68120 08 45 66	114	188	68196 09 45 66	93	185
65100 19 45 66	15	164	65192 19 45 66	17	167	68120 09 45 66	90	189	68196 11 45 66	103	181
65100 29 45 66	51	156	65203 18 45 66	46	157	68120 11 45 66	100	179	68197 11 45 66	103	185
65110 18 45 66	41	168	65203 18 60 66	64	166	68120 12 45 66	118	183	68199 11 45 66	105	185
65110 19 45 66	15	164	65203 19 45 66	17	172	68122 11 45 66	100	190	68200 11 45 66	102	186
65110 29 45 66	51	156	65204 18 45 66	46	157	68124 07 45 66	110	183	68201 39 45 66	86	185
65114 30 45 66	42	168	65205 18 45 66	47	166	68124 08 45 66	114	188	68500 09 45 66	90	179
65115 18 45 66	42	164	65206 18 45 66	47	166	68124 12 45 66	118	189	68505 09 45 66	90	179

Ref.:	Serie	Technic	Ref.:	Serie	Technic
68506 09 43 66	85	179	68911 45	138	198
68506 09 43 66	85	178	68912 45	138	198
68506 09 45 66	84	178	68913 45	138	198
68510 09 45 66	90	178	68914 45	138	198
68511 09 45 66	90	179	68915 45	138	198
68515 09 45 66	91	179	68916 45	138	198
68516 09 43 66	85	179	68917 45	139	198
68516 09 45 66	84	178	9908 0046	139	199
68520 09 45 66	91	178	B63113 26	135	196
68525 09 45 66	91	180	B65113 18	135	196
68526 09 45 66	84	180	CM63110 26	61	171
68527 09 45 66	92	178	CM65110 18	44	165
68530 09 45 66	91	180	CM65110 29	52	168
68531 09 43 66	85	180	CT67110 18	44	165
68531 09 45 66	84	178	CT67110 26	61	171
68535 09 45 66	92	178	DXE2 45	128	192
68540 09 45 66	93	180	DXE5 45	128	192
68545 09 45 66	94	181	DXK1 45	129	192
68550 09 45 66	93	181	DXK3 45	128	191
68555 09 45 66	93	181	DX03 45	128	192
68560 09 45 66	93	181	DXT3 45	128	191
68565 09 45 66	93	181	DXT5 45	128	191
68570 09 45 66	94	181	FRK63400	60	171
68575 09 45 66	94	181	FRK63401	60	171
68580 09 45 66	94	181	FRT65401	46	166
68585 09 45 66	94	181	FRT65402	46	166
68590 09 45 66	92	181	FRV61205	47	166
68595 09 43 66	86	180	FRV61206	47	200
68595 09 45 66	86	179	P130	142	199
68901 45	96	178	P200	142	199
68901 45	106	182	R63112 08	134	194
68902 45	96	187	R63112 26	134	194
68902 45	106	182	R65112 18	134	194
68903 45	96	187			
68903 45	106	183	Recambios/	146	
68904 45	96	187	Spare parts		
68904 45	106	183			
68908 45	96	187			
68908 45	106	183			
68909 45	96	187			
68909 45	106	183			
68910 45	96	187			
68910 45	106	183			



Архангельск (8182)63-90-72
Астана +7(7172)727-132
Белгород (4722)40-23-64
Брянск (4832)59-03-52
Владивосток (423)249-28-31
Волгоград (844)278-03-48
Вологда (8172)26-41-59
Воронеж (473)204-51-73
Екатеринбург (343)384-55-89
Иваново (4932)77-34-06
Ижевск (3412)26-03-58
Казань (843)206-01-48

Калининград (4012)72-03-81
Калуга (4842)92-23-67
Кемерово (3842)65-04-62
Киров (8332)68-02-04
Краснодар (861)203-40-90
Красноярск (391)204-63-61
Курск (4712)77-13-04
Липецк (4742)52-20-81
Магнитогорск (3519)55-03-13
Москва (495)268-04-70
Мурманск (8152)59-64-93
Набережные Челны (8552)20-53-41

Нижний Новгород (831)429-08-12
Новокузнецк (3843)20-46-81
Новосибирск (383)227-86-73
Орел (4862)44-53-42
Оренбург (3532)37-68-04
Пенза (8412)22-31-16
Пермь (342)205-81-47
Ростов-на-Дону (863)308-18-15
Рязань (4912)46-61-64
Самара (846)206-03-16
Санкт-Петербург (812)309-46-40
Саратов (845)249-38-78

Смоленск (4812)29-41-54
Сочи (862)225-72-31
Ставрополь (8652)20-65-13
Тверь (4822)63-31-35
Томск (3822)98-41-53
Тула (4872)74-02-29
Тюмень (3452)66-21-18
Ульяновск (8422)24-23-59
Уфа (347)229-48-12
Челябинск (351)202-03-61
Череповец (8202)49-02-64
Ярославль (4852)69-52-93

Единый адрес для всех регионов: grb@nt-rt.ru || www.genebre.nt-rt.ru